



***Global Installation Guide for Suntech  
Power Bifacial Double Glass Module***

Version 20210101

# ***Table of Contents***

## **Purpose of this guide ..... 2**

General safety

Storage safety

Handling safety

Installation safety

Fire safety

## **Product Identification ..... 4**

## **Mechanical Installation ..... 4**

Selecting the location

General installation

Installation method

## **Electrical Installation ..... 10**

General installation

## **Maintenance ..... 12**

## **Disclaimer of Liability ..... 12**

## **Appendix Simulation ..... 12**

**\* Please read carefully. This document is binding for any warranty case.**

**\* Any installed PV system less than 500m from coastline, please refer to the Near-coast installation manual.**

# Purpose of this guide

This guide contains information regarding the installation and safe handling of Wuxi Suntech Power Co., Ltd photovoltaic module (hereafter is referred to as "Suntech module").

Installers must read and understand the guide before installation. Any questions, please contact our sales department for further explanations. The installer should conform to all safety precautions in the guide and local codes when installing a module.

Before installing a solar photovoltaic system, installers should become familiar with the mechanical and electrical requirement for such a system. Keep this guide in a safe place for future reference (care and maintenance) and in case of sale or disposal of the modules.

## General safety

Modules rated for use in this application class may be used in systems operation at greater than 50V DC or 240W, where general contact access is anticipated. Modules qualified for safety through IEC 61730-1 and this part of IEC 61730 within this application class are considered to meet the requirements for safety class II.

PV modules are recommended to be installed at altitudes of less than 2000 m. Please contact the module supplier for approval in case of installation altitudes more than 2000 m.

Installing solar photovoltaic systems may require specialized skills and knowledge. Installation should be performed only by qualified persons who must be professionally trained and pass the assessment.

Installer must be dressed in protection equipments during installation, including but not limited to safety helmets, safety goggles, safety shoes, anti-cutting gloves, etc.

Installers should assume the risk of all injury that might occur during installation, including, without limitation, the risk of electric shock.

One individual module may generate DC voltages greater than 30 volts when exposed to direct sunlight. Contact with a DC voltage is potentially hazardous and should be always avoided.

Do not disconnect the modules or any electrical part under load..

Photovoltaic solar modules change light energy to direct-current electrical energy. They are designed for outdoor use. Modules may be ground mounted, mounted on rooftops, vehicles or boats. Proper design of support structures is responsibility of the system designers and installers.

Do not use mirrors or other magnifiers to artificially concentrate sunlight on the modules.

When installing the system, abide with all local, regional and national statutory regulations. Obtain a building permit where necessary.

The electrical characteristics are within  $\pm 10$  percent of the indicated values of  $I_{sc}$ ,  $V_{oc}$  and  $P_{max}$  under standard test conditions (irradiance of  $1000 \text{ W/m}^2$ , AM 1.5 spectrum, and a cell temperature of  $25^\circ\text{C}$  ( $77^\circ\text{F}$ )).

Only use equipment, connectors, wiring and support frames suitable for a solar electric systems.

Do not permit constant dew on any part of backsheet of the module.

## Storage safety

Modules shall be installed as soon as possible while arriving at the site. Otherwise, modules shall be stored with methods described as below.

1. When the modules are not unpacked, please note that:

Modules must be placed on a solid flat ground and away from force.

Modules should be stored indoors for avoiding damage to modules and packaging caused by direct sunlight and wind.

Do not be exposed to damp, rain and soaking.

2. When the modules are unpacked, please note that:

Modules must be placed front side down and buffered by soft materials like cardboard or foam on the flat surface for temporary at the site.

Modules must contact soft materials while leaned against the wall. Amount of leaning modules are not more than 3.

Do not lean the module against the support.

Avoid the force on a single point of the module in case of glass exploding.







***Inappropriate module storage will void the warranty.***

## Handling safety

Do not lift the module by grasping the module's junction box or electrical leads.

Do not stand or step on module.

Do not drop the module or allow objects to fall on the module.

To avoid glass breakage, do not place any heavy objects on the module.

Do not set the module down hard on any surface.

Double glass frameless module must be carried by four or more sucking disks instead of hands directly to ensure module can be forced uniformly.

Pay attention to the ground conditions while module carrying. Inappropriate carry, transport and installation may break module.

Standing and Stepping are prohibited under module lifted during installation.

Do not attempt to disassemble the modules, and do not remove any attached nameplates or components from the modules.

Do not apply paint or adhesive to module top surface.

To avoid damage to the back sheet, do not scratch or hit the backsheet.

Avoid setting the panel down hard on any surface, particularly when placing it on a corner.

A panel with broken glass or torn back-skin cannot be repaired and must not be used since contact with any panel surface or the frame can produce electrical shock.

Work only under dry conditions, and use only dry tools. Do not handle panels when they are wet unless wearing the appropriate protective equipment.

When storing un-connected panels outside for any length of time, always cover panels which have the glass facing down to stop water collecting inside the panel and causing damage to exposed connectors.

## Installation safety

Never open electrical connections or unplug connectors while the circuit is under load.

Contact with electrically charged parts of the modules, such as terminals, can result in burns, sparks and lethal shock whether the panel is connected or disconnected..

Do not touch the PV module unnecessarily during installation. The glass surface may be hot; there is a risk of burns and electric shock.

Do not work in the rain, snow or in windy conditions.

Cables shall be located so that they will not be exposed to direct sunlight in order to prevent degradation of cables.

Keep children well away from the system while transporting and installing mechanical and electrical components.

Completely cover the module with an opaque material during installation to keep electricity from being generated.

Do not wear metallic rings, watchbands, earrings, nose rings, lip rings or other metallic objects while installing or troubleshooting photovoltaic systems.

Use only insulated tools that are approved for working on electrical installations.

Abide with the safety regulations for all other components used in the system, including wiring and cables, connectors, charging regulators, inverters, storage batteries and rechargeable batteries, etc.

Under normal outdoor conditions the module will produce current and voltages that are different than those listed in the data sheet. Data sheet values are values expected at standard test conditions. Accordingly, during system design, values of short-circuit current and open-circuit voltage should be multiplied by a factor of 1.25 when determining component voltage ratings, conductor ampacity, fuse ratings and size of controls connected to the modules or system output.

## Fire safety

Refer to your local authority for guidelines and requirements for building or structural fire safety.

The roof construction and installation may affect the fire safety of a building; improper installation may contribute to hazards in the event of fire.

It may be necessary to use components such as earth ground fault circuit breakers, fuses and circuit breakers.

Do not use panels near equipment or locations where flammable gases can be generated or can collect.

Fire resistance of Suntech's bifacial and double glass module is Class C according to IEC61730-2, and is suitable for

mounting over a class A roof. Do not install modules on a roof or building during strong winds in case of accidents.

## Product identification

Each module has three labels on its rear side providing the following information:

**1. Nameplate:** describes the product type; rated power, rated current, rated voltage, open circuit voltage, short circuit current, all as measured under standard test conditions; weight, dimensions etc.; the maximum system voltage is shown on the nameplate. Maximum fuse rating is also shown.

**2. "Pass":** describe inspection date and security class.

**3. Bar code:** each individual module has a unique serial number. The serial number has 18 digits. The 15th and the 16th digit are the week code, and the 17th and the 18th digit are the year code. For example, xxxxxxxxxxxx0106 means the module was made in the first week of 2006. There is only one bar code on module. It is permanently attached to the interior of the module visible when viewing from the front of the module. This bar code is inserted at the beginning of laminating.



### Typical serial number barcode label

**4. Sorting label:** four different marks are shown on this sticker. "QC Pass" assures that the module has passed the quality control examination. "HIPOT" means that it has passed the insulation test. Finally modules are sorted out according to their output current, referred as a corresponding symbol "Ix" attached, in which x takes the value 1, 2 or 3. To get optimal performance out of a string of modules it is recommended to connect only modules of the same "Ix" class (for example only I2 modules) in one given string. The function of the "Barcode" please refer to the "Barcode" instruction mentioned above.



### Sorting label

**Do not remove any label. If the label is removed, the product warranty will no longer be honored by Suntech.**

## Mechanical Installation

### Selecting the location

Select a suitable location for installing the modules.

The modules should be facing south in northern latitudes and north in southern latitudes.

SUNTECH recommend that the minimum installation angle is 10 degree because dust can be washed by rain or dew for better effective light intensity and better ventilation as hot air on and under the module can flow along a direction and the module has higher performance at lower temperature

For detailed information on the best elevation tilt angle for the installation, refer to standard solar photovoltaic installation guides or a reputable solar installer or systems integrator.

The module should not be shaded at any time of the day.

Do not use module near equipment or in locations where flammable gases can be generated or collected.

Artificially concentrated sunlight shall not be directly on the module.

### General Installation

The support module mounting structure must be made of durable, corrosion-resistant and UV-resistant material.

Select the height of the mounting system to prevent the lowest edge of the module from being covered by snow for a long time in winter in areas that experience heavy snowfalls. In addition, assure the lowest portion of the module is placed high enough so that it is not shaded by plants or trees or damaged by sand and stone driven by wind.

When installing a module on a roof or building, ensure that it is securely fastened and cannot fall as a result of wind or snow loads.

Provide adequate ventilation under the double glass module for cooling (10cm minimum air space between module and mounting surface).

Always observe the instructions and safety precautions included with the support frames to be used with the modules.

Do not attempt to drill holes in the glass surface of the modules. To do so will void the warranty.

Modules must be securely attached to the mounting structure.

When installing module on a roof, ensure that the roof construction is suitable. In addition, any roof penetration required to mount the module must be properly sealed to prevent leaks.

When installing a module on a pole, choose a pole and module mounting structure that will withstand anticipated winds for the area.

Care must be taken to avoid low tilt angles which may cause dirt to build-up on the glass against the frame edge.

Dirt build-up on the surface of the panel can cause active solar cells to be shaded and electrical performance to be impaired.

Observe the linear thermal expansion of the module (the recommended distance between 2 modules is 2 cm).

Ensure panels are not subjected to wind or snow loads in excess of the maximum permissible loads and are not subject to excessive forces due to the thermal expansion of the support structure, see the following paragraph for more detailed information.

Regarding the power gain from rear side, Suntech finds out if the clearance between the module and roof or ground can be kept at least 30cm, with its surface treated with high retro-reflective materials like white paint or foil, the bifacial module can bring about 10%~30% power output (Please refer to Page 15 Appendix Simulation).

In order to minimize light shading area, it is recommended to install modules in the direction of breadth.

## Installation methods

Frameless modules can be installed using side clamps or middle clamps, recommend torque is 7Nm-9Nm. Please refer to the Tab1 when installation.

Tab1: Introduction of clamp

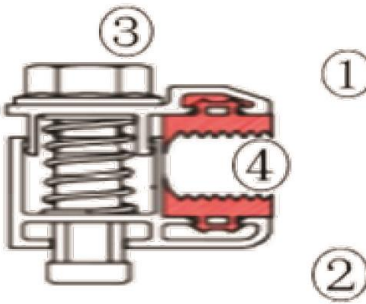
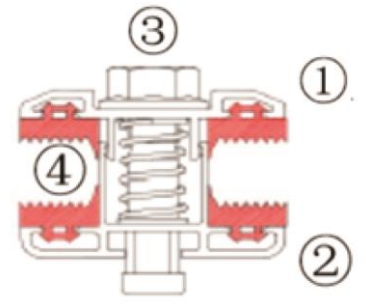
Item	Picture	Description
Side clamp (clamp length $\geq$ 150 mm)		<ol style="list-style-type: none"> <li>1. Upper pressure block</li> <li>2. Lower pressure block</li> <li>3. M8 bolt</li> <li>4. EPDM rubber strip</li> </ol>
Middle clamp (clamp length $\geq$ 150 mm)		<ol style="list-style-type: none"> <li>1. Upper pressure block</li> <li>2. Lower pressure block</li> <li>3. M8 bolt</li> <li>4. EPDM rubber strip</li> </ol>

Framed modules can be installed on the frame using mounting holes, clamps\* or an insertion system. Modules must be installed according to the following examples. Not mounting the modules according to these instructions may void the warranty.

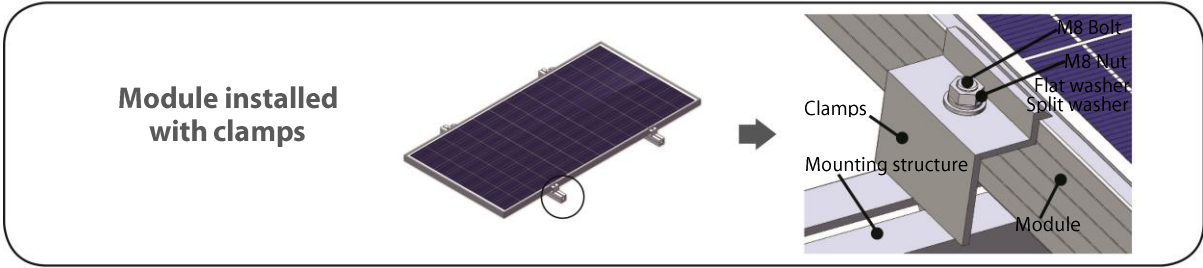
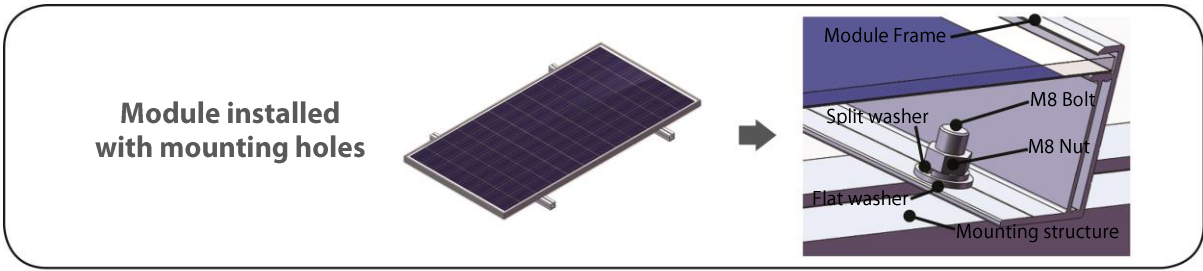

*\* The minimum recommended length for each clamp is 50 mm.*

Module can be installed in both landscape and portrait modes.

The modules must be properly secured to their support so that they can withstand live load conditions, including positive and negative load, to the pressure they have been certified for. It is the installer's responsibility to ensure that the clamps used to secure the modules are strong enough.

When secure the bolts or clamps for framed module, recommend torque is 20Nm-25Nm.

## Attachment guidelines

Select the proper installation method depending on the load(See below for more detailed information).

All installation method herein are only for reference, and Suntech will not provide related mounting components, the system installer or trained professional personnel must be responsible for the PV system's design, installation and mechanical load calculation and security of the system.

With different installation methods, the modules have been tested to withstand the loads of 2400 Pa, 3800 Pa and 5400 Pa according to IEC 61215 standard, equivalent of 1600 Pa (0.232psi), 2500 Pa (0.363psi) and 3600 Pa (0.522psi) respectively under UL 1703 standard.

For each installation, modules can be installed either in portrait or landscape mode. If you integrate our obsolete products and need advice, please contact Suntech Global Customer Support Department for installation instructions based on older manuals.

Suntech Bifacial/Double Glass Module Type	Module Dimension Length × Width × Thickness
W frameless series	1658 mm×992 mm×6 mm
V frameless series	1968 mm×992 mm×6 mm
72/P framed series	1980 mm×992 mm×35 mm
72/N framed series	2018 mm×992 mm×35 mm
A60/P framed series	1704mm×1002 mm×35 mm
A72/P framed series	2028 mm×1002 mm×35 mm
A60/H framed series	1704mm × 1002mm × 35mm
A72/H framed series	2028 mm×1002 mm×35 mm
B60/P framed series	1757 mm×1040 mm×35 mm
	1791 mm×1052 mm×35 mm
	1757 mm×1040 mm×30 mm
B72/P framed series	2115 mm×1052 mm×35 mm

	2096 mm×1040 mm×35 mm
	2096 mm×1040 mm×30 mm
C54/P framed series	1724 mm×1134 mm×35 mm
	1704 mm×1134 mm×35 mm
	1724 mm×1134 mm×30 mm
	1704 mm×1134 mm×30 mm
C66/P framed series	2094 mm×1134 mm×35 mm
	2074 mm×1134 mm×35 mm
	2094 mm×1134 mm×30 mm
	2074 mm×1134 mm×30 mm
C72/P framed series	2279 mm×1134 mm×35 mm
	2257 mm×1134 mm×35 mm
	2279 mm×1134 mm×30 mm
	2257 mm×1134 mm×30 mm



## Suntech bifacial/double glass frameless modules

Picture	
Module Dimension(mm)	1658×992×6 (full size)
Installation Distance a (mm)	300
Clamp Zone b (mm)	250
The torque (N*M)	16~20

Note: The side that junction box exists is rear side.

Picture	
Module Dimension (mm)	1968 × 992 × 6 (full size)
Installation Distance a (mm)	300
Clamp Zone b (mm)	300
Clamp Zone c (mm)	1/2 long side length ± 125
The Torque (N*M)	16~20

Note: The side that junction box exists is rear side.

Tab2: Installation method

Module Dimension	Load capacity	Clamp Length	Quantity of clamps
1658mm×992mm×6mm	±2400Pa	≥150mm	4 clamps
1968mm×992mm×6mm	±2400Pa	≥150mm	6 clamps

Note: 1. Design positive and negative load is respectively 1600Pa and 1600Pa with the safety factor  $\gamma=1.5$ .  
 2. The clamp should cover a distance of at least 10 mm in width, but not extend above cells on both sides.

## Suntech bifacial /double glass framed modules

### 1)Standard mounting method

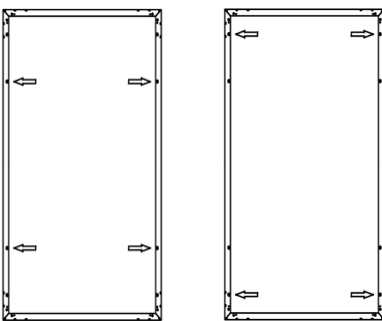
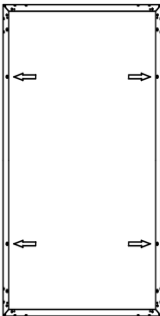
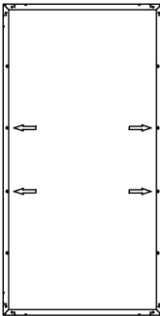
Mounting method*	Mechanical load** The installation method is based on the internal test results in Suntech	Installation location	Module type***
<b>4 bolts installation</b>	<b>Test load:</b> positive 5400Pa negative 3800Pa <b>Design load:</b> positive 3600Pa negative 2533Pa Safety factor: 1.5		72/P framed series 72/N framed series C54/P framed series
<b>4 bolts installation</b>	<b>Test load:</b> positive 5400Pa negative 2400Pa <b>Design load:</b> positive 3600Pa negative 1600Pa Safety factor: 1.5		A60/P framed series A60/H framed series B60/P framed series A72/P framed series A72/H framed series B72/P framed series C66/P framed series C72/P framed series
<b>4 bolts installation</b>	<b>Test load:</b> positive 1600Pa negative 1600Pa <b>Design load:</b> positive 1066Pa negative 1066Pa Safety factor: 1.5		Tracker series***

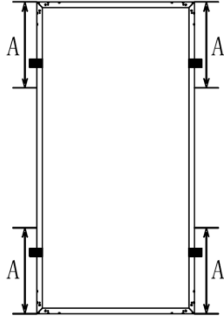
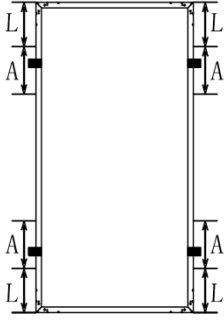
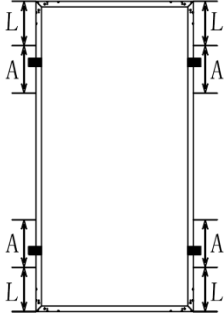
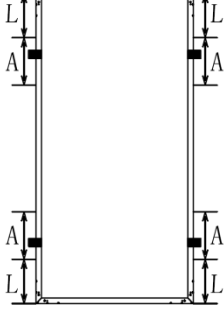
<p><b>4 clamps installation</b></p>	<p><b>Test load:</b> positive 2400Pa negative 2400Pa <b>Design load:</b> positive 1600Pa negative 1600Pa Safety factor: 1.5</p>	 <p>Clamp Zone: <math>A=1/4</math> long frame length <math>\pm 50</math> mm</p>	<p>72/P framed series 72/N framed series</p>
<p><b>4 clamps installation</b></p>	<p><b>Test load:</b> positive 6000Pa negative 3800Pa <b>Design load:</b> positive 4000Pa negative 2533Pa Safety factor: 1.5</p>	 <p>C54/P framed series L=200 mm</p>	<p>C54/P framed series</p>
<p><b>4 clamps installation</b></p>	<p><b>Test load:</b> positive 5400Pa negative 3800Pa <b>Design load:</b> positive 3600Pa negative 2533Pa Safety factor: 1.5</p>	 <p>B60/P framed series L=200 mm 72/P framed series L=280 mm 72/N framed series L=280 mm Clamp zone: A = 300 mm</p>	<p>A60/P framed series A60/H framed series B60/P framed series 72/P framed series 72/N framed series</p>
<p><b>4 clamps installation</b></p>	<p><b>Test load:</b> positive 5400Pa negative 3800Pa <b>Design load:</b> positive 3600Pa negative 2533Pa Safety factor: 1.5</p>	 <p>C66/P framed series L=200mm A72/P framed series L = 300 mm B72/P framed series L = 380 mm Clamp zone: A = 200 mm</p>	<p>C66/P framed series A72/P framed series A72/H framed series B72/P framed series</p>

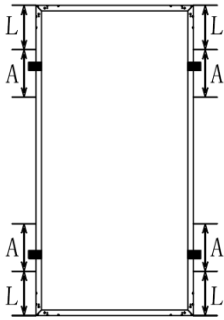
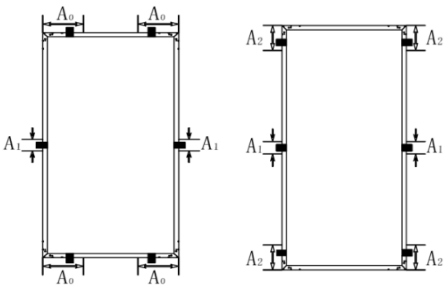
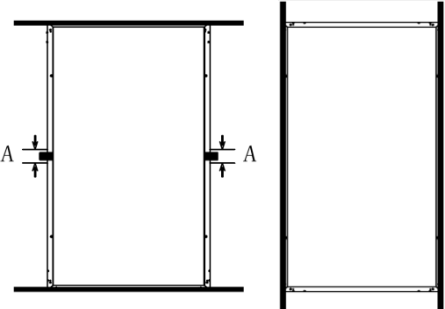
<p><b>4 clamps installation</b></p>	<p><b>Test load:</b> positive 5400Pa negative 2400Pa <b>Design load:</b> positive 3600Pa negative 1600Pa Safety factor: 1.5</p>	 <p>C72/P framed series L = 380 mm Clamp zone: A = 200 mm</p>	<p>C72/P framed series</p>
<p><b>6 clamps installation</b></p>	<p><b>Test load:</b> positive 5400Pa negative 3800Pa <b>Design load:</b> positive 3600Pa negative 2533Pa Safety factor: 1.5</p>	 <p>Clamp zone: <math>A_0 = 1/4</math> short frame length <math>\pm 50</math> mm <math>A_1 = 100</math>mm <math>A_2 = 200</math>mm</p>	<p>A60/P framed series A60/H framed series B60/P framed series 72/P framed series B72/P framed series 72/N framed series</p>
<p><b>Insertion installation</b></p>	<p><b>Test load:</b> positive 5400Pa negative 3800Pa <b>Design load:</b> positive 3600Pa negative 2533Pa Safety factor: 1.5</p>	 <p>Clamp zone: A = 100 mm</p>	<p>C66/P framed series 72/P framed series 72/N framed series</p>



## 2) Customized mounting method

Note: The tested mechanical load listed hereby are based on Suntech internal test results with specific clamps.

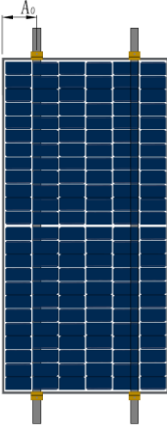
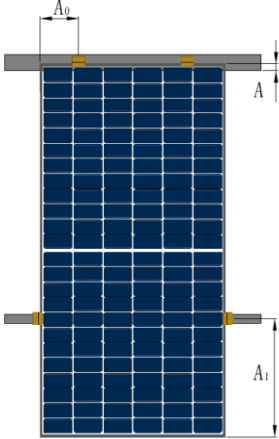
Mounting method*	Mechanical load** The installation method is based on the internal test results in Suntech.	Installation location	Module type***
<p><b>4 clamps short end mounting</b></p>	<p><b>Test load:</b> positive 2400Pa negative 1600Pa <b>Design load:</b> positive 3600Pa negative 1067Pa Safety factor: 1.5</p>	 <p>A0=1/4 short frame length ± 50mm</p>	<p>C54/P framed series A60/P framed series A60/H framed series B60/P framed Series 72/P framed Series A72/P framed Series A72/H framed Series B72/P framed Series</p>
<p><b>4 clamps installation</b></p>	<p><b>Test load:</b> positive 2400Pa negative 2400Pa <b>Design load:</b> positive 1600Pa negative 1600Pa Safety factor: 1.5</p>	 <p>A ≥ 40mm; A0=1/4 short frame length ± 50mm; A1=360~560mm</p>	<p>C54/P framed series C66/P framed series A60/P framed series A60/H framed series B60/P framed Series 72/P framed Series A72/P framed Series A72/H framed Series B72/P framed Series</p>

\*The module clamps must not come into contact with the front glass or deform the frame in any way. Avoid shading effects from the module clamps and insertion systems. Drainage holes in the module frame must not be closed or obscured by the clamps.

\*\*The loads of 2400 Pa, 3800 Pa and 5400 Pa are under IEC standard. The installation methods applicable for 5400 Pa are also relevant for 3800 Pa and 2400 Pa. The installation methods applicable for 3800 Pa are also relevant for 2400 Pa.

\*\*\*The mounting holes reserved for tracker mounting system with special accessories. The length of module over 2 meters, whose load value needs to be confirmed by supplier respectively.

\*\*\*\*60/P and 72/P framed series refer to 60 cell and 72 cell P type modules respectively. 60/N and 72/N framed series refer to 60 cell and 72 cell N type modules respectively.

## Electrical Installation

### Electrical property

Module under standard testing conditions of: irradiance of 1000W /m<sup>2</sup>, cell temperature of 25 °C and air mass of AM1.5,

maximum over-current protection is 15A.

Under normal conditions, a Photovoltaic module is likely to experience conditions that produce more current and/or voltage than reported at standard test conditions. Accordingly, the values of  $I_{sc}$  and  $V_{oc}$  marked on this module should be multiplied by a factor of 1.25 when determining component voltage ratings, conductor ampacities, fuse sizes, and size of controls connected to the PV output.

Voltages are additive when modules are connected in series, and modules currents are additive when Modules are connected in parallel, as illustrated in Figure 1.

Modules with different electrical characteristics must not be connected directly in series.

## Series wiring

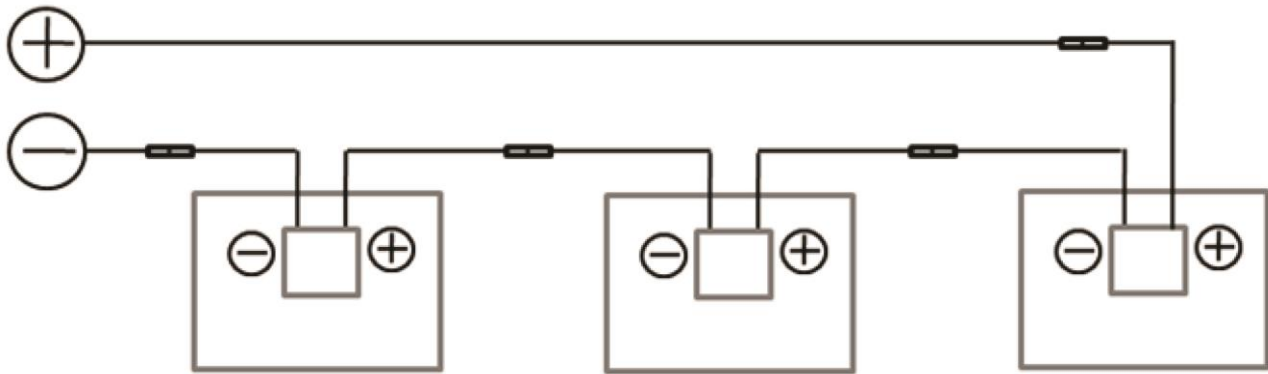

## Parallel wiring

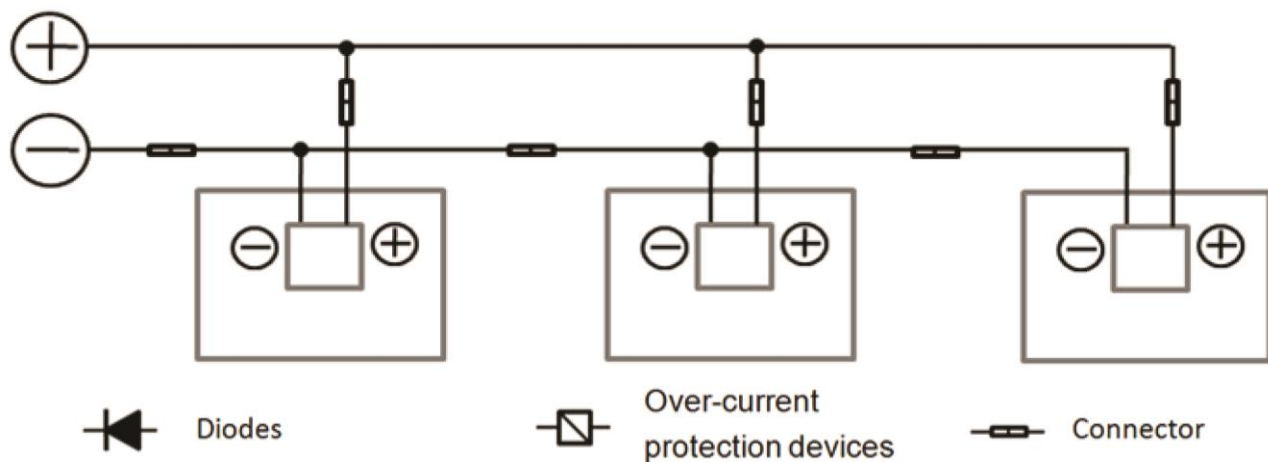

Figure 1: Electrical diagrams of series and parallel wiring.

The maximum number of Modules that can be connected in series within a string must be calculated in accordance with applicable regulations in such a way that the specified maximum system voltage (The maximum system voltage of bifacial module is DC 1500V) of the modules and all other electrical DC components will not be exceeded in open-circuit operation at the lowest temperature expected at the PV system location.

Correction factor for the open-circuit voltage can be calculated based on the following formula:  $CV_{oc} = [1 - \alpha(25 - T)]\%$ .  $T$  is the lowest expected ambient temperature at the system location.  $\alpha$  (%/°C) is the temperature coefficient of the selected module  $V_{oc}$  (Refer to corresponding datasheet).

Dimension	Maximum system voltage	Maximum number of modules
1658×992×6mm	1500V	35
1968×992×6mm	1500V	29

Note: The data above are calculated based on the temperature in Wuxi. The maximum number of modules that can be connected in series within a string for the specific project must be calculated based on the actual local temperature.

If there is reverse current exceeding the maximum fuse current flowing through the module, use over-current protection device with the same specifications to protect it.

## Grounding

For grounding and bonding requirements of double glass framed modules, please refer to regional and national safety and electricity standards. If grounding is required, use a recommended connector type for the grounding wire.

For grounding, this guide refers to module frame grounding. If grounding is required, make sure module frames (metal exposed to touch) are always grounded.

Suntech recommends always refer to local state and national code requirements for PV module grounding. Suntech highly recommends negative grounding if it's allowed by local authorities.

When attaching the frame grounding hardware and wire to the frame it must be placed corresponding to the ground symbol stamped location to ensure proper electrical connection.

Suntech recommends one of the following parts for grounding:

1) Use M5 bolt and washer to bond the ground wire and aluminum frame through the grounding hole (as shown below).

The tightening torque is 3-7 Nm. All nuts and washers should be made of stainless steel. The 4-14 mm<sup>2</sup> (AWG 6-12) exposed copper wire recommended as ground wire.

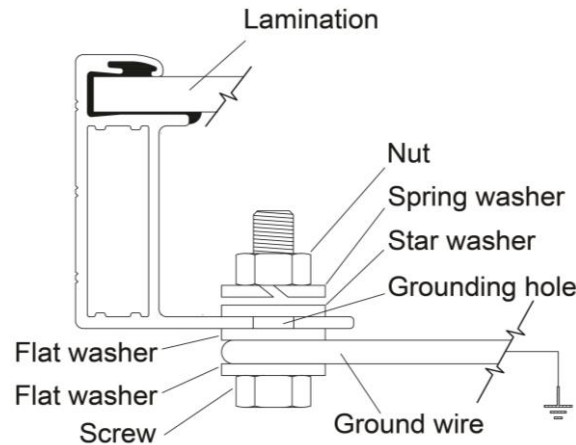

2) Use WEEB-DPF to bond solar modules to module mounting brackets (grounding part is tested to UL467)

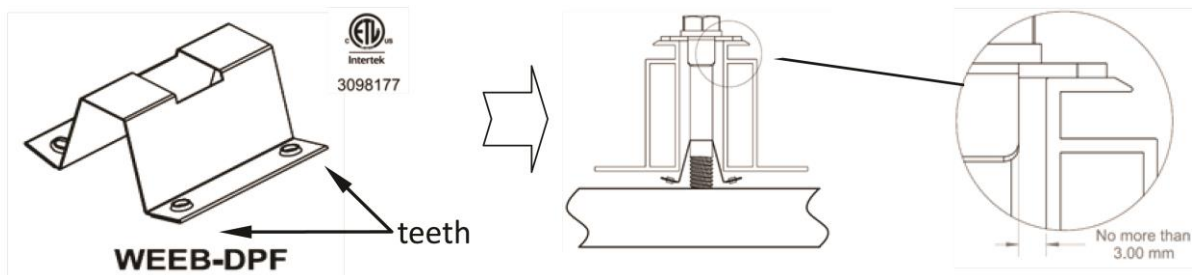

Notice that WEEB teeth is positioned completely under the edge of the module frame.

When position of solar module is finalized, torque fasteners to 20.5 N-m/15 ft-lb using general purpose anti-seize on threads.

For more information, please contact supplier: BURNDY, <http://www.we-llc.com>

3) Use Schletter clamps to bond solar module to module mounting brackets (grounding part is tested to UL467).

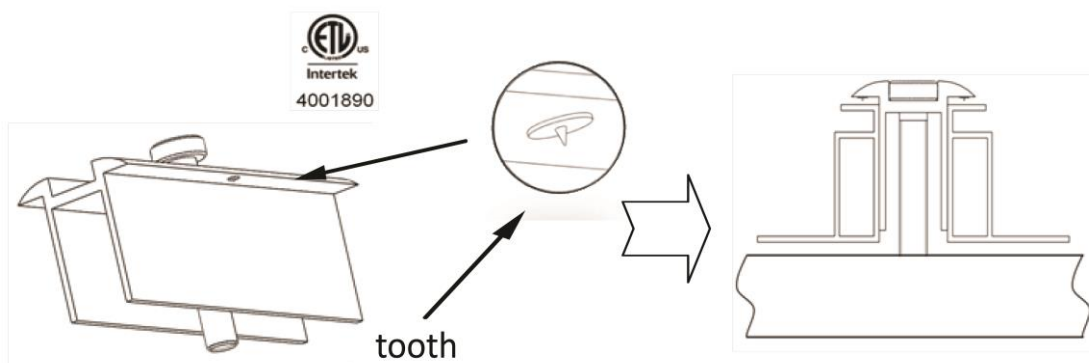

Recommend fastening torque is 20.5 N-m/15 ft-lb.

For more information, please contact supplier: Schletter, <http://www.solar.schletter.eu>

## Cables and Wiring

The connectors at the opposite ends of these wires allow easy series connection of Suntech's bifacial double glass modules by firmly inserting the positive connector of a Module into the negative connector of another module until the connector is fully seated.

Use field wiring with suitable cross-sectional areas that are approved for use at the maximum short-circuit current of the

Modules. Suntech recommends installers use only sunlight resistant cables qualified for direct current (DC) wiring in PV systems. The minimum wire size should be 4 mm<sup>2</sup>.

Cables should be fixed to the mounting structure in such a way that mechanical damage of the cable and/or the modules is avoided. Do not apply stress to the cables. Use appropriate means, such as sunlight resistant cable ties and/or wire management clips specifically designed, to attach cable to the modules. While the cables are sunlight resistant and waterproof, where possible, avoid direct sunlight exposure and water immersion of the cables.

## Connectors

Keep connectors dry and clean, and ensure that connector caps are hand tight before connecting the Modules. Do not attempt making an electrical connection with wet, soiled, or otherwise faulty connectors. Avoid sunlight exposure and water immersion of the connectors. Avoid connectors resting on the ground or roof surface.

Faulty connections can result in arcing and electrical shock. Check that all electrical connections are securely fastened. Make sure that all locking connectors are fully engaged and locked.

## Bypass Diodes

The junction boxes used on Suntech's bifacial double glass modules contain bypass diodes wired in parallel with the PV cell strings. In the case of partial shading, the diodes bypass the current generated by the non-shaded cells, thereby limiting modules heating and performance losses.

Bypass diodes are not over-current protection devices.

In the event of a known or suspected diode failure, installers or maintenance providers should contact Suntech. Never attempt to open the junction box by yourself.

## Maintenance

Suntech recommends the following maintenance in order to ensure optimum performance of the module:

Clean the glass surface of the module as necessary. Always use water and a soft sponge or cloth for cleaning. A mild, non-abrasive cleaning agent can be used to remove stubborn dirt.

Check the electrical and mechanical connections every six months to verify that they are clean, secure and undamaged.

If any problem arises, have them investigated by a competent specialist.

Attention, observe the maintenance instructions for all components used in the system, such as support frames, charging regulators, inverters, batteries etc.

## Data table

Module Type	STP400S-A72Pth+
Maximum Power at STC (P <sub>max</sub> ) Tolerance: ±5%	400.W
Optimum Operating Voltage (V <sub>mp</sub> )	40.7V
Optimum Operating Current (I <sub>mp</sub> )	9.83A
Open Circuit Voltage (V <sub>oc</sub> ) Tolerance: ±5%	48.5V
Short Circuit Current (I <sub>sc</sub> ) Tolerance: ±5%	10.34A
Maximum System Voltage (V)	1500/1000

## Disclaimer of liability

Because the use of this manual and the conditions or methods of installation, operation, use and maintenance of photovoltaic (PV) product are beyond Suntech's control, Suntech does not accept responsibility and expressly disclaims liability for loss, damage, or expense arising out of or in any way connected with such installation, operation, use or maintenance.

No responsibility is assumed by Suntech for any infringement of patents or other rights of third parties, which may result



from use of the PV product. No license is granted by implication or otherwise under any patent or patent rights.

The information in this manual is based on Suntech's knowledge and experience and is believed to be reliable; but such information including product specification (without limitations) and suggestions do not constitute a warranty, expresses or implied. Suntech reserve the right to change the manual, the PV produce, the specifications, or product information sheets without prior notice.

## Appendix Simulation

Module height: 0.6 ~ 1.5m

Albedo 0.15 ~ 0.85

Title angle 30°, south face, latitude 36°

Array distance 4.5m

Suntech recommended a minimum height of 1m

Albedo	Surface in practical	Module height from ground (m)/Rear side gain				
		0.6	0.8	1.0	1.25	1.5
<b>0.15</b>	Dark or wet soil, meadows	4.0%	4.5%	4.9%	5.1%	5.1%
<b>0.30</b>	Wet sand, dry soil, concrete	9.1%	11.1%	10.8%	11.2%	11.2%
<b>0.50</b>	Dry grass, dry sand, new concrete	16.2%	17.9%	19.0%	19.6%	19.7%
<b>0.70</b>	Old snow	23.3%	25.4%	26.9%	27.7%	27.8%
<b>0.80</b>	Fresh snow, white paint	26.5%	29.0%	30.7%	31.5%	31.7%
<b>0.85</b>	Aluminum	28.2%	30.8%	32.6%	33.6%	33.7%

Note: The data above are only applicable to bifacial modules.

**Address: No.9 Xinhua Road Wuxi, China 214028**

**Customer Service Hot Line: +86 400 8888 009 Fax: +86 510 8534 3321**

# 目录

<b>安全指南</b> .....	<b>14</b>
总体安全	
操作安全	
安装安全	
消防安全	
<b>产品鉴别</b> .....	<b>16</b>
<b>机械安装</b> .....	<b>16</b>
场地选择	
常规安装	
安装方法	
<b>电气安装</b> .....	<b>22</b>
常规安装	
<b>维护</b> .....	<b>24</b>
<b>免责声明</b> .....	<b>24</b>
<b>附录模拟</b> .....	<b>24</b>

\*请仔细阅读。该文件对任何保修情况都具有约束力。

\*距海岸线 500 米内安装光伏系统，请参考近海安装手册。

# 安装指南

本指南包含有关无锡尚德太阳能电力有限公司光伏组件（以下简称为“尚德组件”）的安装方法和安全操作的相关信息。

安装人员在安装前必须阅读并理解该指南。如有任何问题，请联系尚德销售部获得更详细的信息。安装人员必须遵循本指南中说明的所有安全预防措施、当地法律的规定。

在安装太阳能光伏系统前，安装人员应当熟悉其机械和电气要求。将本指南存放于安全处用于日后参考（维护和保养）以及在将组件出售或处理时使用。

## 总体安全

组件适用于大于50伏直流电压或240瓦功率以上的系统，通过IEC61730-1及IEC61730标准即符合安全等级II方可用于安全安装。

光伏组件推荐安装海拔不超过2000米，如安装海拔超过2000米，请及时与厂家联系评估。

安装光伏系统需要专业技术和知识。安装只能由有资质的人员进行，并且安装人员须经过安全知识培训并且考核合格。

安装过程中请佩戴好个人防护用品，包括但不限于：安全帽、护目镜、安全鞋、安全带、防割手套等。

安装人员必须承担所有在安装过程中可能出现的危险，包括但不限于电击危险。

单块组件在阳光直射的条件下可产生超过30伏的直流电。与直流电接触有很高的潜在风险，请在任何情况下都避免接触直流电。

请勿在工作状态下断开组件和任何电器件的连接。

光伏组件将光能转化成直流电能，它们适用于户外安装。组件可以安装在地面、屋顶上，车辆或船上。系统设计师和安装人员负责支撑结构的合理设计。

请勿使用反光镜或其他放大镜将阳光直接聚焦于组件上。

安装系统时，须遵守所有当地、地区性和国家级别的法定法规。如有必要，请取得安装许可证。

组件在标准测试条件下，铭牌所标称的电性能参数与实际值有±10%的偏差。（辐照度1000 W/m<sup>2</sup>，AM 1.5光谱，电池温度为25 °C (77 °F)。

光伏发电系统只能使用与之相匹配的设备、连接器、接线和支架。

请勿将组件背板的任何部位持续用水冲击。

## 存放安全

组件到达现场接收后应尽快使用和安装，如不及时安装，必须妥善保管和存放组件，具体要求和措施如下：

### 1. 整托组件未拆包时，须注意：

必须单托放置在坚实平整的地面上，禁止受到挤压。

应存放于室内，避免阳光直射和风力对组件及包装的破坏。

禁止受潮、雨淋及雨水的浸泡。在气候恶劣的情况下，应及时采取组箱件防雨措施（加防雨布、料场排水）和组件箱防晒措施（料场遮阳），并固定住整托组件，避免到倒塌。

现场组件如需吊装，须检查一下包装是否破坏，如没有破坏，可兜住托盘底部进行吊装，如被破坏则用其他方式转运。

### 2. 拆包后的组件存放，须注意：

现场临时放置组件时，组件正面朝下放置在平整的表面上，必须使用软性材料加以缓冲，如纸板、泡沫纸等材料，且多块组件摆放，需上下四角位置一致，严禁任何错位。

需要组件斜立在墙面，尽量使组件的两条长边完全与地面和墙面接触，在接触位置放置海绵等柔软物品，最多叠放组件3块。

严禁将组件靠着支架，或用木板抵挡背面，易导致组件受损。

禁止一切外力及外物对组件玻璃单点进行撞击及磕碰，以防止组件爆裂。



不规范的组件存放将导致尚德质保失效。

## 操作安全

请勿抓住组件接线盒或引出线提起组件。

请勿站在或踩在组件上。

请勿使组件掉落或使物体坠落于组件上。

请避免玻璃碎裂。请勿在组件上放置任何重物或尖锐物体。

组件要轻拿轻放。

禁止直接用手搬运双玻无框组件，须用四个或四个以上的吸盘搬运，保证组件受力均匀。

组件的搬运过程中须注意路面状况，不恰当的搬运、运输或安装可能损坏组件并使质保无效。

组件安装时如需抬高，禁止安装人员站在组件下方。

请勿尝试拆解组件及组件上的任何铭牌或元件。

请勿在组件玻璃或背板上使用油漆或粘合剂。

为避免损坏背板，请勿刮擦、撞击背板。

面板放于任何平面均要轻拿轻放，特别是将其放在角落时。

面板上的玻璃破损或背板损坏时将无法修复，禁止使用此类面板，因为接触此类面板平面或支架将导致触电。

只能在干燥环境中作业，且只能使用干燥的工具。请勿在未佩戴任何保护措施的条件下在潮湿的环境中作业。

如需在户外将未安装的组件存放一段时间，须始终遮盖组件并保证玻璃面向下，防止组件内部积水和连接器的损坏。

## 安装安全

请勿在电路有负载的情况下打开电气连接处或拔出连接器。

如果触碰组件带电零部件，例如连接器，无论面板是否已接通，可能导致烧伤、火星和致命电击。

在安装过程中请勿在不必要时触碰组件。玻璃表面和支架可能有产生高温；会产生烧伤和电击危险。

请勿在下雨、下雪或大风天气情况下安装组件。

为防止组件绝缘效果降低，请避免使其长期暴露在阳光下。

运输和安装机械与电气元件时请使儿童远离该系统。

安装时使用不透明材料将组件完全盖住，防止产生电损。

安装或修理光伏系统时请勿佩戴金属戒指、腕表、耳环、鼻环、唇环或其它金属物质。

只能使用符合相关电气安装标准的绝缘工具。

遵守当地的安全规定（例如，关于操作发电站的安全规定）和关于系统其它部件，包括接线和电缆、连接器、充电调节器、逆变器、蓄电池、可充电的电池等的安全规定。

正常情况下，一块光伏组件产生的电流和电压可能与数据表所列的电流和电压不同。数据表所列数值为标准试验条件下产生的预期值。因此在计算组件额定电压、额定电流、保险熔断和连接至组件或系统输出的控件规格时，应当将标记在该组件上的 $I_{sc}$ 和 $V_{oc}$ 的值乘以1.25的系数。



## 消防安全

咨询您当地的部门获得关于安装或建筑消防安全方面的指导和要求。

顶层结构和安装可能影响建筑的消防安全；不恰当的安装可能导致火灾危险。

在当地部门要求下，使用例如接地故障断路器、保险丝、断路器之类的设备。

请勿在可能产生可燃性气体的环境中或设备附近操作面板。

根据IEC61730-2标准，尚德双面及双玻组件的防火等级为C，适合安装于类别A的屋顶上。在大风天气下请勿将组件安装在屋顶或建筑物上，避免发生事故。

## 产品鉴别

每个组件有三个标签，提供下列信息：

1. 铭牌：说明了产品类型；额定功率、额定电流、额定电压、开路电压、短路电流，重量、尺寸等所有数值均在标准检测条件下测量得出；系统最大电压显示在铭牌上。最大保险丝额定值也显示在铭牌上。
2. “通过”：描述检测日期和安全等级。
3. 条形码：每个单一的组件有一个专属的序列号。该序列号有18位数字。第15位和第16位是周数编码，第17位和第18位是年份编码。例如，XXXXXXXXXXXX0106表示组件在2006年第1周组装和检测。每个组件只有一个条形码。它将永远黏贴在组件内部，并且可以从组件前部顶端看到。该条形码在层压前被插入。



### 条形码标签

4. 分档标签:该标签上显示了四个不同的标志。“QC Pass”确保组件已通过了质量控制检查。“HIPOT”表示已通过了绝缘测试。最后根据组件的输出电流将组件筛选，由相应的“lx”符号表示，其中x表示值1,2和3为使组件串获得最优性能，建议只在一个串中选用“lx”类别相同的组件，（例如只有lx2组件）。“条形码”的作用请参考上述“条形码”介绍。



### 分档标签

请勿取下任何标签。取下任一张标签将导致尚德质保无效。

## 机械安装

### 场地选择

为组件的安装选择合适的场地。

组件在北纬下应面朝南，南纬下面朝北。

尚德建议安装组件的倾斜角度不宜低于10°，以便灰尘被雨水冲刷，并获得更有效的光强度和通风，因为组件上方和下

方的热风可沿一个方向流动且组件在较低温度下效率更高。

如需关于最佳安装角度的详细信息，请参考标准太阳能光伏安装指南或咨询专业太阳能安装人员和系统集成商。

组件在任何时间都不应被阳光遮挡。

请勿在可能产生或收集易燃气体的设备附近或场所中使用组件。

组件不能直接被人工聚集的太阳光照射。

## 常规安装

组件的支撑结构必须使用耐用、防锈和抗紫外材料制作。

在冬天有大量降雪的地区，请选择合适的支撑系统高度，使组件最低边缘在任何时候都不会被雪覆盖。另外，请保证组件最低部分放置的高度足够，使植物、树木不会遮挡住阳光，或被风刮来的沙石损坏。

当组件被安装在屋顶或建筑物上，请确保组件被固定，且不会因风载荷或雪载荷而掉落。

双玻组件请为组件底部提供充足的通风以便冷却（屋顶平面与组件的支架之间通常建议应有最少10厘米的距离）。

始终遵守组件支架的说明指导和安全防范措施。

请勿尝试在组件的玻璃表面上钻孔，否则将导致尚德质保无效。

组件必须稳固放置在支撑结构上。

将组件安装于屋顶前，请确保屋顶的结构合理。另外，任何需要安装组件的屋顶必须密封处理防止漏水。

将组件安装于立柱上时，选择的立柱和组件支撑结构必须可以承受当地可能的风载荷。

请避免较小倾斜角，否则会引起灰尘积聚在支架边缘的玻璃。

面板表面上积聚的灰尘可能导致太阳能电池被遮挡且电气性能受损。

观察组件的热膨胀（两个组件间的距离建议最少为2厘米）。

确保组件不会承受超过最大允许载荷的风载和雪载，而且不会承受支撑结构热膨胀产生力。不允许组件重叠或者超出屋顶。请参考下列安装方法获得详细信息。

对于组件背面产生的功率增益，尚德发现如果组件和屋顶或地面之间的空隙能够保持至少30厘米，利用高逆向反光材料例如白漆或箔纸对表面进行处理，那么双面组件就可以带来额外10%-30%的功率输出(具体请参照第29页附录模拟)。

为最大程度缩小遮光区域，建议从宽度方向安装组件。

## 安装方式

无框组件可以使用侧面夹具或中间夹具，安装时建议的扭矩7Nm-9Nm，不能超过10Nm，安装时请参看表1。

表1：夹具描述

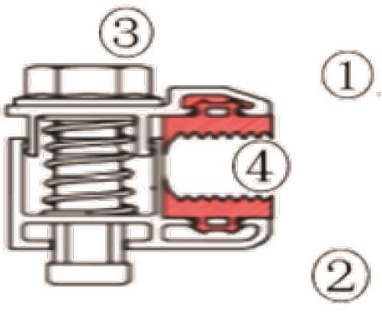
项目	图示	描述
侧面夹具 (压块长度 $\geq 150\text{mm}$ )		1. 上压力块 2. 下压力块 3. M8螺栓 4. EPDM橡胶条

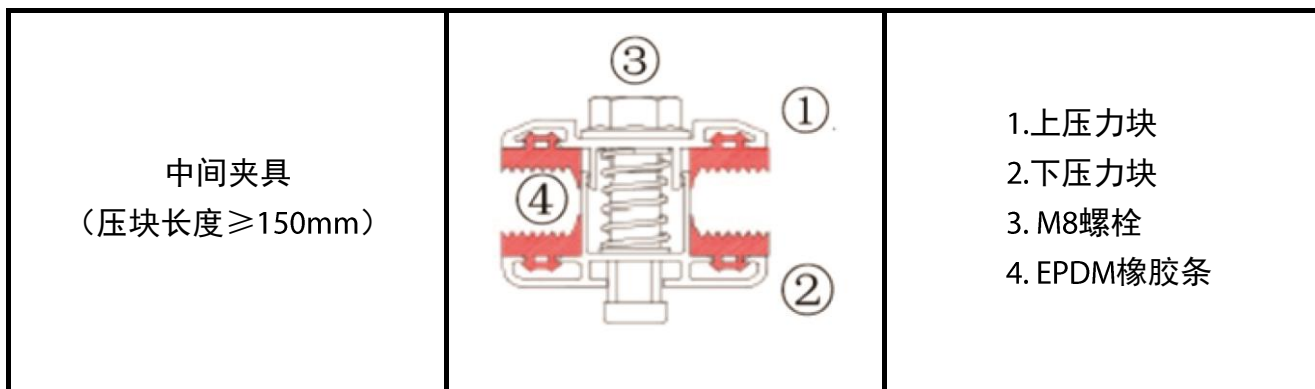

带框组件可以使用安装孔、夹具\*或滑槽被安装在支架上。必须根据下列样例安装组件。没有根据下列说明安装组件，会使质保无效。

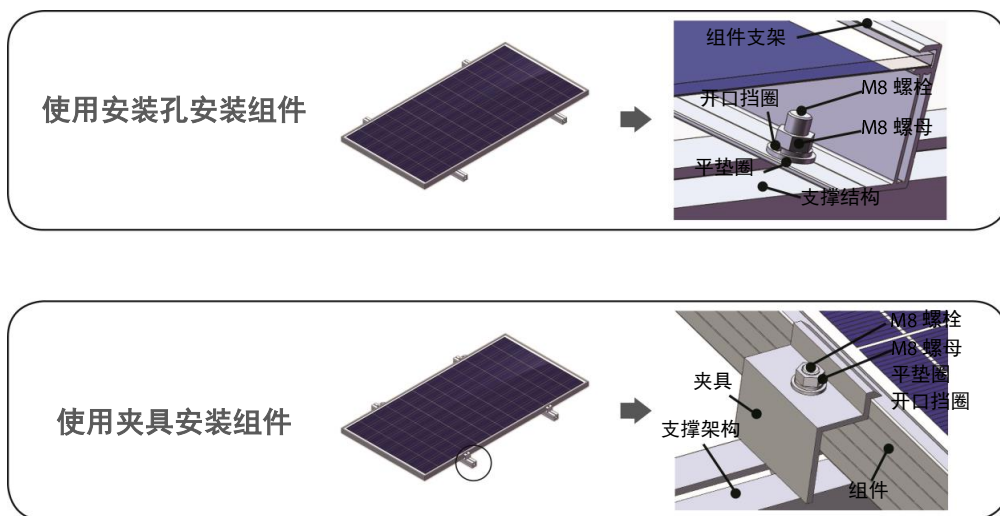

**\*每个夹具最小建议长度为50 mm**

组件可以采用横向和纵向安装。

组件必须稳固固定在支架上，以便承受相应的正负压，建议的扭矩为20Nm-25Nm。安装人员必须负责确保用于固定组件的夹具有足够的强度。

## 安装指南

根据载荷需求选择合适的安装方法（参考下文获得更详细信息）。

下面图示的安装方式仅供参考。尚德不提供相关安装部件，系统安装商和经过培训的专业人员，必须对整个项目的光伏系统的设计，安装和载荷计算及安全负责。

经检测，使用不同的安装方法时，组件可以承受2400 Pa、3800 Pa和5400 Pa的载荷，（IEC61215标准）分别等同于UL1703标准下的1600 Pa (0.232psi)、2500 Pa (0.363psi) 和 3600 Pa (0.522psi)。

对于每种安装方法，组件均可纵向或横向安装。如果曾安装尚德的旧组件需要咨询，请联系尚德全球质量&客户支持部门获取旧的安装说明以作为参考。

尚德双面/双玻组件型号	组件尺寸（长×宽×厚）
W无框系列	1658 mm × 992 mm × 6 mm
V无框系列	1968 mm × 992 mm × 6 mm
72/P带框系列	1980 mm × 992 mm × 35 mm
72/N带框系列	2018 mm × 992 mm × 35 mm

A60/P帶框系列 A60/H帶框系列	1704 mm × 1002 mm × 35 mm
A72/P帶框系列	2028 mm × 1002 mm × 35 mm 1990 mm × 998 mm × 35 mm
A72/H帶框系列	2028 mm × 1002 mm × 35 mm
B60/P帶框系列	1757 mm × 1040 mm × 35 mm 1791 mm × 1052 mm × 35 mm 1757 mm × 1040 mm × 30 mm
B72/P帶框系列	2115 mm × 1052 mm × 35 mm 2096 mm × 1040 mm × 35 mm 2096 mm × 1040 mm × 30 mm
C54/P帶框系列	1724 mm×1134 mm×35 mm 1704 mm×1134 mm×35 mm 1724 mm×1134 mm×30 mm 1704 mm×1134 mm×30 mm
C66/P帶框系列	2094 mm×1134 mm×35 mm 2074 mm×1134 mm×35 mm 2094 mm×1134 mm×30 mm 2074 mm×1134 mm×30 mm
C72/P帶框系列	2279 mm×1134 mm×35 mm 2257 mm×1134 mm×35 mm 2279 mm×1134 mm×30 mm 2257 mm×1134 mm×30 mm

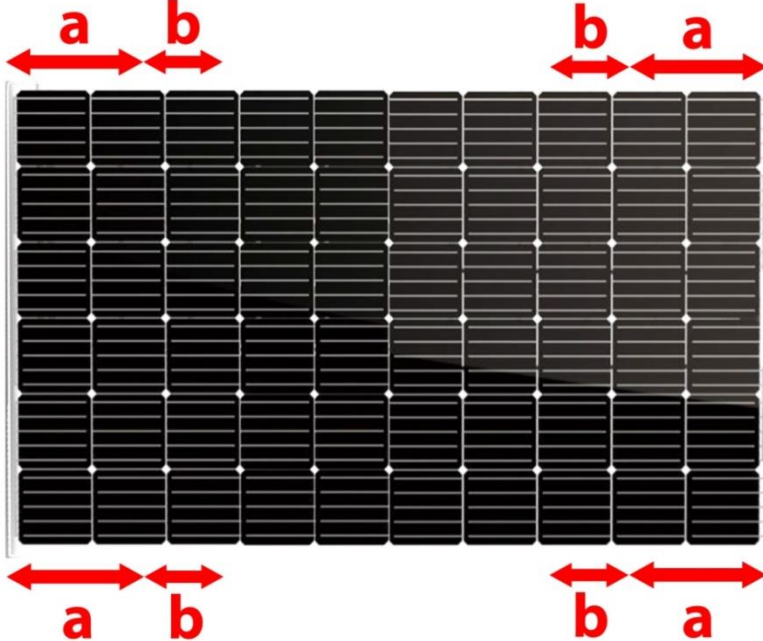

## 尚德双面/双玻无边框组件

<p>图示</p>	
<p>组件尺寸 (mm)</p>	<p>1658×992×6</p>
<p>安装距离a (mm)</p>	<p>300</p>
<p>夹具区b (mm)</p>	<p>250</p>
<p>扭矩 (N·M)</p>	<p>16~20</p>

注：接线盒所在侧为组件背面。

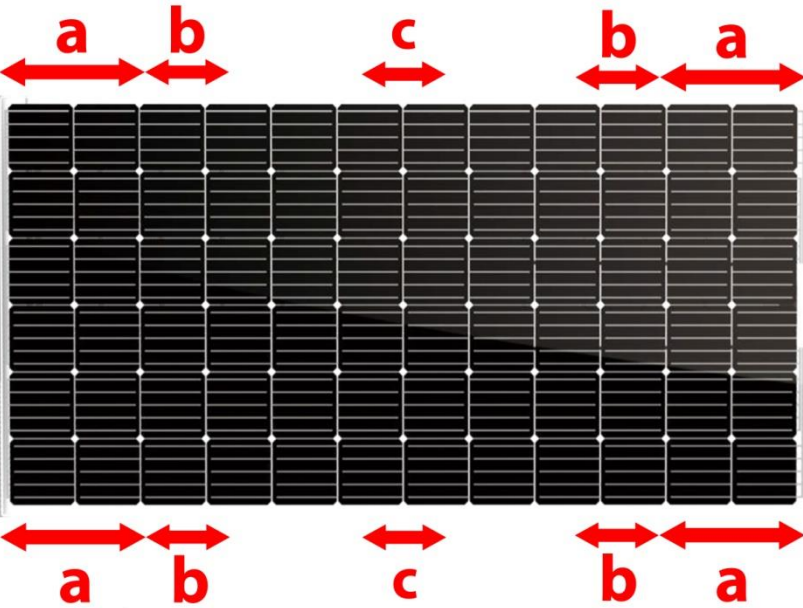
<p>图示</p>	
<p>组件尺寸 (mm)</p>	<p>1968×992×6 (全片)</p>
<p>安装距离a (mm)</p>	<p>300</p>
<p>夹具区b (mm)</p>	<p>300</p>
<p>夹具区c (mm)</p>	<p>1/2长边长度±125</p>
<p>扭矩 (N·M)</p>	<p>16~20</p>

注：接线盒所在侧为组件背面。

表2：安装方法（适用于无边框组件）

组件尺寸	负载能力	夹具长度	夹具数量
1658 mm × 992 mm × 6 mm	±2400 Pa	≥150 mm	4个夹具
1968 mm × 992 mm × 6 mm	±2400 Pa	≥150 mm	6个夹具

注：1.设计正负压分别为1600 Pa和1600 Pa，安全系数 $\gamma = 1.5$ 。

2.夹具宽度方向所占距离至少10 mm，但不应超出两侧上方的电池。

## 尚德双面/双玻带边框组件

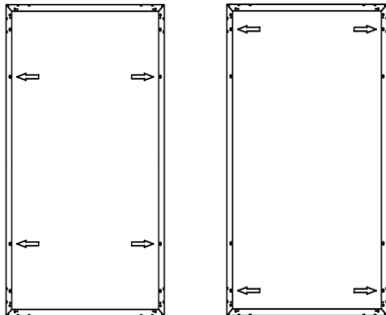
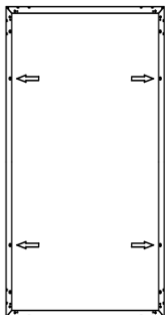
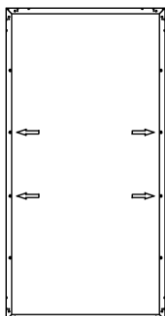
安装类型*	适用载荷** <small>以下测试载荷值是基于尚德内部测试结果</small>	安装图示	适用版型***
四螺栓安装	测试载荷： 正压 5400Pa/负压 3800Pa 设计载荷： 正压 3600Pa/负压 2533Pa 安全系数 1.5		C54/P带框系列 72/P带框系列 72/N带框系列
四螺栓安装	测试载荷： 正压 5400Pa/负压 2400Pa 设计载荷： 正压 3600Pa/负压 1600Pa 安全系数 1.5		A60/P带框系列 A60/H带框系列 B60/P带框系列 A72/P带框系列 A72/H带框系列 B72/P带框系列 C66/P带框系列 C72/P带框系列
四螺栓安装	测试载荷： 正压 1600Pa/负压 1600Pa 设计载荷：正压 1066Pa/ 负压 1066Pa 安全系数 1.5		Tracker系列***

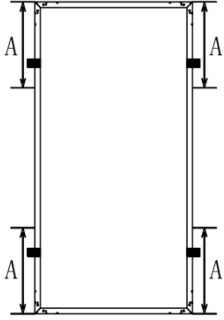
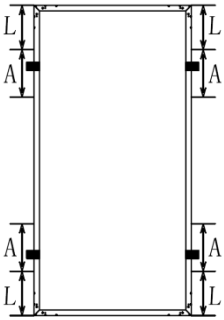
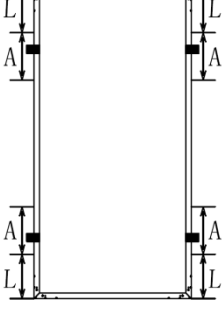
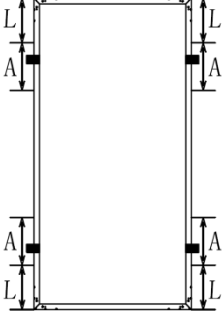
<p><b>四夹具安装</b></p>	<p>测试载荷： 正压 2400Pa/负压 2400Pa 设计载荷： 正压 1600Pa/负压 1600Pa 安全系数 1.5</p>	 <p>夹具区：A=1/4长边框长度±50 mm</p>	<p>C54/P带框系列 72/P带框系列 72/N带框系列</p>
<p><b>四夹具安装</b></p>	<p>测试载荷： 正压 5400Pa/负压 3800Pa 设计载荷： 正压 3600Pa/负压 2533Pa 安全系数 1.5</p>	 <p>72/P带框系列L=280 mm 72/N带框系列L=280 mm Clamp zone: A = 300 mm</p>	<p>C54/P带框系列 72/P带框系列 72/N带框系列</p>
<p><b>四夹具安装</b></p>	<p>测试载荷： 正压 5400Pa/负压 3800Pa 设计载荷： 正压 3600Pa/负压 2533Pa 安全系数 1.5</p>	 <p>A72/P带框系列L = 300 mm B72/P带框系列L = 380 mm 夹具区：A = 200 mm</p>	<p>A60/P带框系列 A60/H带框系列 B60/P带框系列 A72/P带框系列 A72/H带框系列 B72/P带框系列 C66/P带框系列</p>
<p><b>四夹具安装</b></p>	<p>测试载荷： 正压 5400Pa/负压 2400Pa 设计载荷： 正压 3600Pa/负压 1600Pa 安全系数 1.5</p>	 <p>C72/P带框系列L = 380 mm 夹具区：A = 200 mm</p>	<p>C72/P带框系列</p>

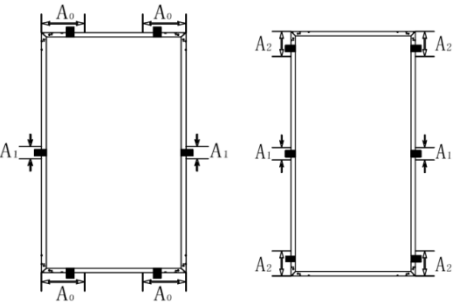
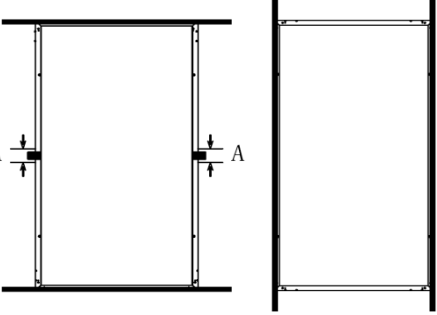
<p><b>六夹具安装</b></p>	<p>测试载荷： 正压 5400Pa/负压 3800Pa 设计载荷： 正压 3600Pa/负压 2533Pa 安全系数 1.5</p>	 <p>夹具区：<math>A_0 = 1/4</math>短边框长度<math>\pm 50</math> mm <math>A_1 = 100</math> mm <math>A_2 = 200</math> mm</p>	<p>C54/P带框系列 A60/P带框系列 A60/H带框系列 B60/P带框系列 72/P带框系列 B72/P带框系列 72/N带框系列</p>
<p><b>滑槽安装</b></p>	<p>测试载荷： 正压 5400Pa/负压 3800Pa 设计载荷： 正压 3600Pa/负压 2533Pa 安全系数 1.5</p>	 <p>夹具区：<math>A = 100</math> mm</p>	<p>C66/P带框系列 72/P带框系列 72/N带框系列</p>

## 2) 客户定制化安装方式

注：以下所列出的测试载荷值基于具体压块型号的尚德内部测试结果。

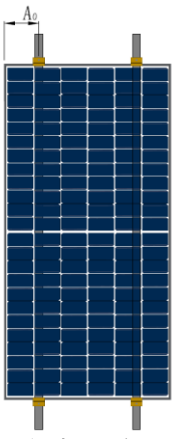
安装类型*	适用载荷** <small>以下测试载荷值是基于尚德内部测试结果</small>	安装图示	适用版型***
<p><b>4 压块短边框固定</b></p>	<p>测试载荷： 正压 2400Pa/负压 2400Pa 设计载荷： 正压 1600Pa/负压 1600Pa 安全系数 1.5</p>	 <p><math>A_0 = 1/4</math> 短边框长度<math>\pm 50</math>mm</p>	<p>C54/P带框系列 A60/P带框系列 A60/H带框系列 B60/P 有框系列 72/P 有框系列 A72/P有框系列 A72/H有框系列 B72/P有框系列</p>

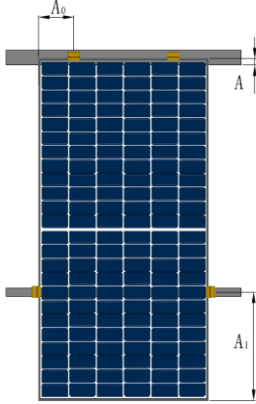
<p><b>4 压块长短边混合安装</b></p>	<p>测试载荷： 正压 2400Pa/负压 2400Pa 设计载荷： 正压 1600Pa/负压 1600Pa 安全系数 1.5</p>	 <p><math>A \geq 40\text{mm};</math> <math>A_0 = 1/4 \text{ 短边框长度} \pm 50\text{mm};</math> <math>A_1 = 360 \sim 560\text{mm}</math></p>	<p>C66/P带框系列 A60/P带框系列 A60/H带框系列 B60/P有框系列 72/P有框系列 A72/P有框系列 A72/H有框系列 B72/P有框系列</p>
---------------------------	---	---	---

\*任何情况下，组件夹具都不能触碰到前端玻璃或使支架变形，以避免组件夹具和滑槽遮挡电池片。夹具不能封住或盖住组件支架上的排水孔。

\*\*2400 Pa、3800 Pa和5400 Pa为IEC标准下的载荷。适用于5400 Pa 的安装方式可覆盖3800Pa和2400 Pa。适用于3800 Pa的安装方式可覆盖2400 Pa。

\*\*\*安装孔位为tracker单轴安装支架预留，需搭配tracker专用配件安装使用。长度超过2米的光伏组件，载荷值需要单独确认。

\*\*\*\*60/P和72/P分别指60片和72片P型组件，60/N和72/N分别指60片和72片N型组件。

## 电气安装

### 电气属性

符合以下标准试验条件的组件：辐照度 $1000\text{W}/\text{m}^2$ ，电池温度 $25^\circ\text{C}$ ，大气质量AM1.5，最大过电流保护15 A。

正常情况下，光伏组件可能会产生超出标准试验条件下的电流和/或电压。因此在计算组件额定电压、额定电流、保险熔断和连接至组件或系统输出的控件规格时，应当将标记在该组件上的 $I_{sc}$ 和 $V_{oc}$ 的值乘以1.25的系数。

组件串联连接时电压累加，组件并联连接时电流累加，如图1所示。

具有不同电气特性的组件不得直接串联连接。

### 串联接线

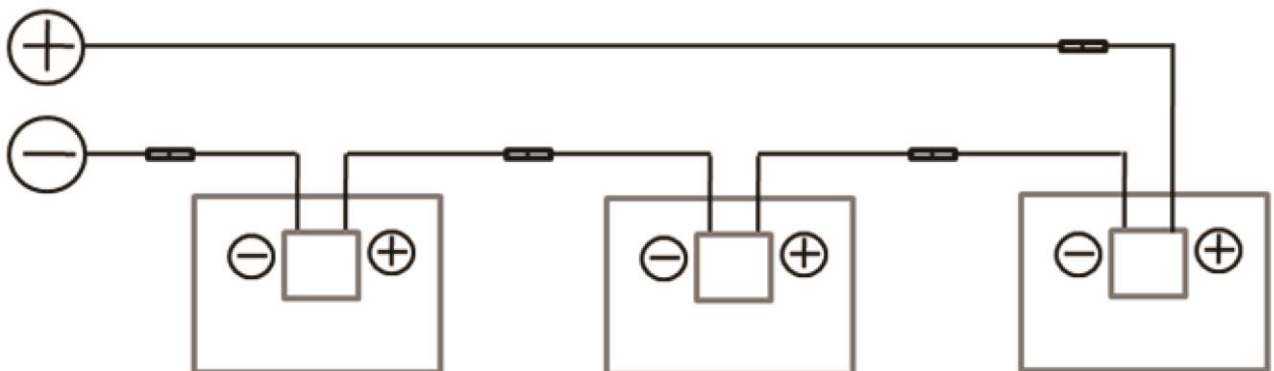



## 并联接线



图1：串联和并联接线电气图

必须严格按照相关规定来计算一个组串内可以串联连接的最大组件数量，组件的规定最大系统电压（双面组件的最大系统电压为直流1500V）及所有其他电子直流元器件不超过光伏系统所在地最低温度下开路状态的数值。

可以利用以下公式来计算开路电压校正系数： $C_{Voc}=[1-\alpha(25-T)]\%$ 。T是指系统所在地的预计最低环境温度。 $\alpha(\%/^{\circ}\text{C})$ 是指所选组件 $V_{oc}$ 的温度系数（参见相应数据表）。

尺寸	最大系统电压	最大组件数量
1658 × 992 × 6 mm	1500V	35
1968 × 992 × 6 mm	1500V	29

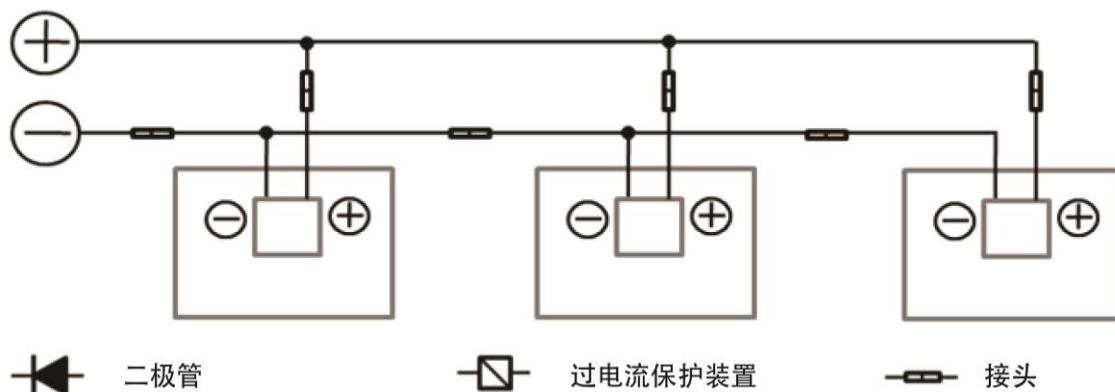
注：以上数据是以无锡地区气温计算，具体项目串最大组件数量需要以当地的实际气温计算。

如果反向电流超出流经组件的最大保险丝电流，使用相同规格的过电流保护装置实施保护。

## 电缆与布线

通过线缆两端的接头将一个组件的正极接头牢固插入另一个组件的负极接头，直到完全连接到位，从而实现尚德双面双玻组件的串联连接。

采用经批准可用于组件最大短路电流的合适横截面积的线缆。尚德建议安装人员使用适合光伏系统直流布线的耐日光电缆。最小线径应为4 mm<sup>2</sup>。

电缆固定在安装结构上时，需避免损伤电缆和/或组件。请勿对电缆施加压力。采用正确的方法，例如耐日光扎线带和/或专用线夹，将电缆固定在组件上。线缆若具有耐日光及防水性能，也应尽量避免受阳光直射以及浸水。

## 接地

对于双玻带框组件接地和连接要求，请参考地区性和国家性安全和电气标准。如果要求接地，请为接地接线使用建议的连接器类型。

本册中的接地指的是组件支架接地。如果要求接地，确保组件支架（暴露的、可接触的的金属部分）始终是接地的。

尚德建议始终参考当地和国家有关光伏组件接地的规范和要求。如果当地机构允许，尚德强烈建议使用负极接地。

必须将支架接地硬件和接线安装到支架上所标注的合适的接地标志位置以确保合适的电气连接。

尚德推荐使用下述一种接地零件：

1) 如下图所示，使用M5螺栓、垫圈在边框预留接地孔处将接地线缆与边框连接固定并形成导通，螺母拧紧力矩为3~7 N·m。螺母、垫圈均使用不锈钢材质，接地线推荐使用4~14 mm<sup>2</sup> (AWG6-12) 外露铜线。

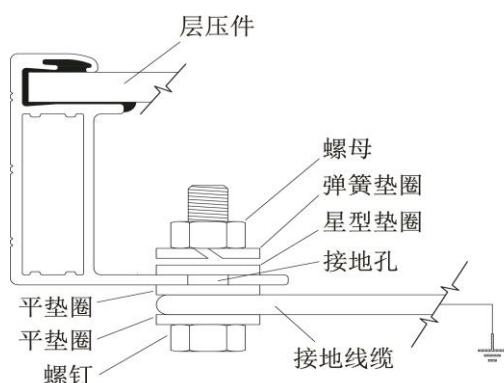

2) 使用WEEB-DPF将太阳能组件安装至组件安装支架上（接地零件接受UL467测试）。

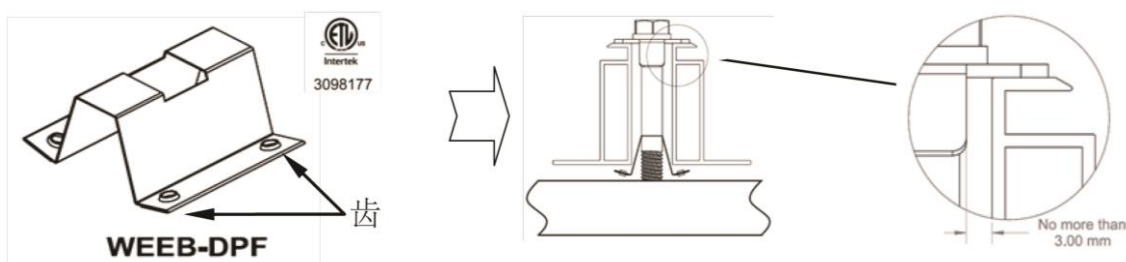

注意：WEEB齿应完全放置在组件支架的边缘下方。

当太阳能组件的位置最终确定后，通常使用20.5牛-米/15英尺-磅的扭矩紧固件放置螺纹卡住。

欲获取更多信息。请联系供应商：BURNDY, <http://www.we-llc.com>。

3) 使用Schletter夹具将太阳能组件安装至组件安装支架（接地零件通过UL467测试）。

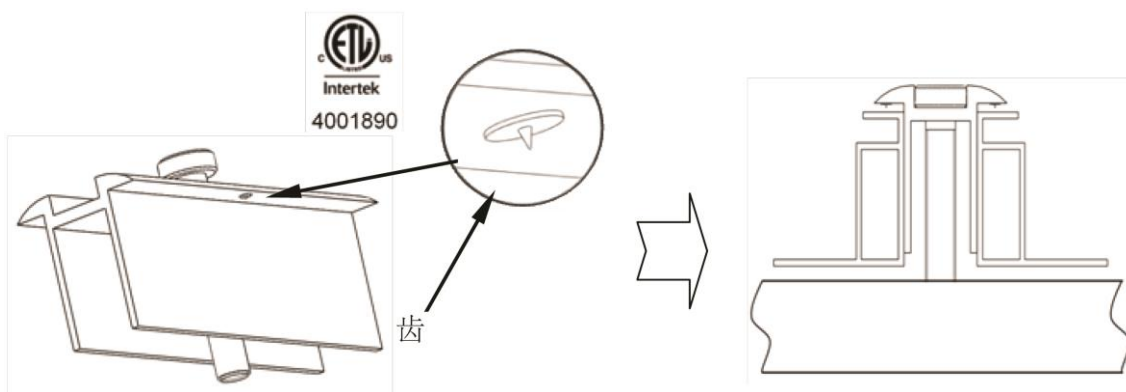

建议夹紧扭矩是20.5牛-米/15英尺-磅。

欲获取更多信息，请联系供应商：Schletter, <http://www.solar.schletter.eu>。

## 接头

保持接头干燥清洁，在连接组件之前确保用手上紧接头盖。请勿试图将潮湿、脏污或有故障的接头进行电气连接。避免接头受阳光直射以及浸水。避免接头放在地面或屋顶表面。

错误连接会造成电弧及电击。检查所有电气连接是否安全牢固。确保所有锁定接头完全到位并锁定。

## 旁路二极管

尚德双面双玻组件所用接线盒中包含旁路二极管和光伏电池串并联。部分遮挡的情况下，二极管绕开未被遮挡电池所产生的电流，从而限制组件发热及性能损失。

旁路二极管并非过电流保护装置。

如果发生已知或疑似二极管故障，安装人员或维护提供商应联系尚德。请勿试图私自打开接线盒。

## 维护

为确保组件的最佳性能，尚德建议采取下列维护措施：

根据污染情况，经常清洁玻璃表面。清洁时请使用清水和柔软的非磨蚀性海绵或布料。也可以使用温和的、非磨蚀性的清洁剂去除顽固污渍。

每隔6个月检查电气、接地和机械连接部位，确保它们干净、安全、没有损坏。

若有任何问题，请向专业太阳能服务供应商咨询并询求建议。

注意：请遵守太阳能制造商对系统中所有组件的维护说明，例如支架、充电调节器、逆变器、电池等。

## 免责声明

因使用本手册，以及光伏产品的安装、运行、使用和维护条件或方法超出尚德的控制，对此类安装、运行、使用或维护引起的或与其有关的任何损失、损害或费用，尚德明确声明不承担任何责任。

无锡尚德对因使用该组件而导致对第三方专利权或其他权利的侵犯不承担任何责任。概未通过暗示或依据任何专利或专利权给予任何许可。

本手册所含信息均基于尚德的知识和经验、是可靠的；但是此类信息包括但不限于产品规格以及建议不构成任何明示或暗示的保证。尚德保留变更本手册、光伏产品、规格书或产品信息表的权利，无需提前发出通知。

## 附录 背面发电量模拟

组件安装高度：0.6 ~ 1.5米

地面反射率0.15 ~ 0.85。

倾斜角度30°，南向安装，纬度36

阵列前后间距4.5米

无锡尚德推荐最小安装高度为1米

反射率	地面材质	组件安装高度(米)/背面增益				
		0.6	0.8	1.0	1.25	1.5
<b>0.15</b>	深色或潮湿土壤、草地	4.0%	4.5%	4.9%	5.1%	5.1%
<b>0.30</b>	潮湿沙地、干燥土壤、混凝土	9.1%	11.1%	10.8%	11.2%	11.2%
<b>0.50</b>	干燥沙地、新浇混凝土	16.2%	17.9%	19.0%	19.6%	19.7%
<b>0.70</b>	陈雪	23.3%	25.4%	26.9%	27.7%	27.8%
<b>0.80</b>	新下的雪、白漆	26.5%	29.0%	30.7%	31.5%	31.7%
<b>0.85</b>	铝箔	28.2%	30.8%	32.6%	33.6%	33.7%

注：以上数据仅适用于双面组件。

地址：江苏省无锡市新吴区新华路9号，邮编214028

客户服务热线：+864008888009 传真：+8651085343321