

*Global Installation Guide for
Suntech Power Standard
Photovoltaic Module*

Version 20210101

Table of Contents

Purpose of this guide 2

General safety

Handling safety

Installation safety

Fire safety

Product Identification 3

Mechanical Installation..... 4

Selecting the location

General installation

Installation method

Attachment guidelines

Electrical Installation 10

General installation

Grounding

Maintenance 12

* Please read carefully. This document is binding for any warranty case.

* Any installed PV system less than 500m from coastline, please refer to the Near-coast installation manual.

Purpose of this guide

This guide contains information regarding the installation and safe handling of Wuxi Suntech Power Co., Ltd photovoltaic module (hereinafter referred to as "module"). Wuxi Suntech Power Co., Ltd referred to as "Suntech".

Installers must read and understand this guide prior to installation. For any questions, please contact Suntech's Global Quality & Customer Support department or our local representatives for more detailed information. Installers must follow all safety precautions as described in this guide as well as local requirement and regulations by law or authorized organizations.

Before installing a solar photovoltaic system, installers should familiarize themselves with its mechanical and electrical requirements. Keep this guide in a safe place for future reference (care and maintenance) and in case of sale or disposal of the modules.

Suntech modules are tested and certified for installation worldwide. Different regions may have different regulations for solar PV installations. In this guide, hereinafter "IEC Only" is used to refer to regions where IEC standard applies, e.g. Europe, Middle East, most of Asia Pacific countries; "UL Only" is used to refer to regions where UL standard applies, e.g. United States, Canada; all other references are global.

General safety

Modules that fall under this application class may be used in system operation at more than 50V DC or 240W, where general contact access is anticipated. Modules qualified for safety under IEC 61730-2 and within this application class are considered to meet the requirements for Safety Class II (IEC Only).

PV modules are recommended to be installed at altitudes of less than 2000m.

Installing solar photovoltaic systems requires specialized skills and knowledge. Installation must only be performed by authorized and trained personnel.

Installers must assume all risks of injury that might occur during installation, including, but not limited to, the risk of electric shock.

One single module may generate more than 30V DC when exposed to direct sunlight. Contact with a DC voltage is potentially hazardous and should be always avoid.

Do not disconnect the modules or any electrical part under load.

PV modules generate electricity when exposed to sunlight. Number of modules string connected can cause lethal shock and burn hazards. Only authorized and trained person should have access to the modules.

Photovoltaic solar modules convert light energy to direct current electrical energy. They are designed for outdoor use. Modules can be ground mounted, mounted on rooftops. The proper design of support structures lies within the responsibility of the system designers and installers.

When installing the system, abide to all local, regional and national statutory regulations. Obtain a building permit if necessary.

The electrical characteristics are within ± 3 percent of the indicated values of I_{sc} , V_{oc} and P_{max} under standard test conditions (irradiance of 1000 W/m², AM 1.5 spectrum, and a cell temperature of 25 °C (77 °F)).

Only use equipment, connectors, wiring and support frames suitable for solar electric systems.

Do not use mirrors, other magnifiers or artificially concentrated sunlight onto the modules.

Always use fall protection equipment when working from heights of 6 feet (183cm) or above. Follow Occupational Safety and Health Act (OSHA) or local governing safety regulations regarding Fall Protection. (UL Only)

Do not sit, stand, step or walk on any side of the module, including the frames.

Do not permit any part of the module(s) to be submerged or allow for constant water to soil the module(s) unless it's natural rain fall or periodic cleaning.

Do not permit constant dew on any part of backsheets of the module.

Handling safety

Do not lift the module by holding the module's junction box or electrical leads.

Do not place any heavy or sharp objects on the module.

Be cautious when placing the module down onto a surface, particularly when placing it in a corner.

Inappropriate transport and installation may break the module and void the warranty.

Do not attempt to disassemble the modules, and do not remove any attached nameplates or components from the modules.

Do not apply paint or adhesive to the module top surface or backsheet.

To avoid damage to the backsheet and cells, do not scratch, dent or hit the backsheet. During the transportation, do not to apply direct pressure on the backsheet or front glass.

Do not drill holes in the frame. This may compromise the frame strength, cause corrosion of the frame and void the warranty.

Do not scratch the anodized coating of the frame (except for grounding connections at the grounding connection point on the back side of the module). It may cause corrosion of the frame or compromise the frame strength.

A module with broken glass or torn backsheet cannot be repaired and must not be used since contact with any module surface or the frame can cause an electric shock.

Work only under dry conditions, and use only dry tools. Do not handle modules under wet conditions unless wearing appropriate protective equipment.

When storing uninstalled modules outdoors for any period of time, always cover the modules and ensure that the

glass faces down on a soft flat surface to prevent water from collecting inside the module and causing damage to exposed connectors.

Purpose of this guide

Installation safety

Never disconnect electrical connections or unplug connectors while the circuit is under load.

Contact with electrically active parts of the modules, such as terminals, can result in burns, sparks and lethal shock whether or not the module is connected.

Do not touch the PV module unnecessarily during installation. The glass surface and the frame may be hot; there is a risk of burns and electric shock.

Do not work in the rain, snow or in windy conditions.

Avoid exposing cables and connectors to direct sunlight and scratches or cuts in order to prevent insulation degradation.

Use only insulated tools that are approved for working on electrical installations.

Keep children well away from the system while transporting and installing mechanical and electrical components.

Completely cover the module with an opaque material during installation to prevent electricity from being generated.

Do not wear metallic rings, watchbands, earrings, nose rings, lip rings or other metallic objects while installing or troubleshooting photovoltaic systems.

Follow the safety regulations (e.g., safety rules for working on electrical power plant stations) of your regions and for all other system components, including wires and cables, connectors, charging regulators, inverters, storage batteries, rechargeable batteries, etc.

Under normal conditions, a photovoltaic module is likely to experience conditions that produce more current and/or voltage than reported at standard test conditions. Accordingly, the values of I_{sc} and V_{oc} marked on this module should be multiplied by a factor of 1.25 when determining component voltage ratings, conductor current ratings, minimum factor of fuse sizes, and size of controls connected to the PV output.

Only use same connectors to connect modules to form a string, or connect to another device. Removing the connectors will void the warranty.

Fire Safety

Consult your local authority for guidelines and requirements for building or structural fire safety.

Roof constructions and installations may affect the fire safety of a building; improper installation may create hazards in the event of a fire.

Use components such as ground fault circuit breakers and fuses as required by local authority.

Do not use modules near equipment or in places where flammable gases may be generated.

The modules have been rated Fire Class C, and are suitable for mounting on to a Class A roof.

Product identification

Each module has three labels providing the following information:

1. Nameplate: describes the product type; rated power, rated current, rated voltage, open circuit voltage, short circuit current, all as measured under standard test conditions; weight, dimensions etc.; the maximum system voltage is 600 volts, 1000V or 1500 volts depending on the product family DC for UL standard and 1000 volts DC for IEC standard. Depending on the products some are UL/IEC listed to 1 000 volts and 1500 V while other UL products are 600 volts. Check your nameplate or contact your local representative for details.

2. Barcode: each individual module has a unique serial number. The serial number has 18 digits. The 15th and the 16th digits are the week code, and the 17th and the 18th digits are the year code. For example, STP xxxxxxxxxxxxxx2414 means the module was assembled and tested in the 24th week of 2014. Each module has only one bar code. It is permanently attached to the interior of the module and is visible from the top front of the module. This bar code is inserted prior to laminating.



Typical serial number barcode label

3. Sorting label: four different marks are shown on this sticker. "QC Pass" assures that the module has passed the

quality control examination. "HIPOT" means that it has passed the insulation test. Finally modules are sorted out according to their output current, referred as a corresponding symbol "Ix" attached, in which x takes the value 1, 2 or 3. To get optimal performance out of a string of modules it is recommended to connect only modules of the same "Ix" class (for example only I2 modules) in one given string. The function of the "Barcode" please refer to the "Barcode" instruction mentioned above.



Sorting label

Do not remove any labels. Removing a label will make the Suntech warranty void.

Mechanical Installation

Selecting the location

Select a suitable location for installing the modules.

The modules should face south in northern latitudes and north in southern latitudes.

For detailed information on the best installation angle, refer to standard solar photovoltaic installation guides or consult a reputable solar installer or systems integrator.

Modules should not be shaded at any time. If a module is shaded or even partially shaded, it will fail to perform at ideal conditions and result in lower power output. A permanent and/or regular shade on the module voids the warranty.

This installation manual is applicable for all PV system of 500 m or more away from the coastline. If you need to install your system less than 500m from the coast line please refer to Near-coast installation manual (www.suntech-power.com) or contact Suntech's Customer Support department or our regional representatives.

Do not use modules near equipment or in locations where flammable gases may be generated or collected.

General Installation

Before installing modules check for any optical deviations. Any optical deviations noticed after system installed may void warranty. Any potential costs for labor, material or other cost such as documentation, safety or performing the (de/ re-) installation will not be covered.

The module mounting structure must be made of durable, corrosion-resistant and UV-resistant material. Always use a tested and certified mounting structure approved for your system design.

In regions with heavy snowfall in winter, select the height of the mounting system so that the lowest edge of the module is not covered by snow for any length of time. In addition, ensure that the lowest portion of the module is placed high enough so that it is not shaded by plants, trees or damaged by ground soil moved by or through the air.

For ground mounting systems, the minimum distance Suntech recommend from the ground to the bottom of the module is at least 24 inches (60cm).

Modules must be securely attached to the mounting structure. For Clamping System installation methods, the recommended maximum compression for each clamp is 2900 PSI (20 Mpa) in order to avoid potential damages to module frames. Follow the instruction of the clamping system supplier.

Provide adequate ventilation under the modules in conformity to your local regulations. A minimum distance of 10 cm between the roof plane and the frame of the module is generally recommended.

Always observe the instructions and safety precautions included with the module support frames.

Before installing modules on a roof, always ensure the roof construction is suitable. In addition, any roof penetration required to mount the module must be properly sealed to prevent leaks.

Dust building up on the surface of the module can impair with the module performance. The modules shall be installed with a tilt angle no less than 10 degrees, making it easier for dust to be removed by rain. A flat angle requires more frequent cleaning.

Observe and take into account the linear thermal expansion of the module frames (the recommended minimum distance between two modules is 2 cm).

Always keep the front and backsheet of the module free from foreign objects, plants and vegetation, structural elements, which could come into contact with the module, especially when the module is under mechanical load.

When installing a module on a pole, select a pole and module mounting structure that will withstand the anticipated wind load and snow load for the area.

Ensure modules are not subjected to wind or snow loads exceeding the maximum permissible loads, and are not subject to excessive forces due to the thermal expansion of the support structures. Never allow modules overlap or exceeds the rooftop: Refer to the following installation methods for more detailed information.

Installation methods

Modules can be installed on the frame using mounting holes, clamps* or an insertion system, recommend torque is 20Nm-25Nm. Modules must be installed according to the following examples. Not mounting the modules according to these instructions may void the warranty.

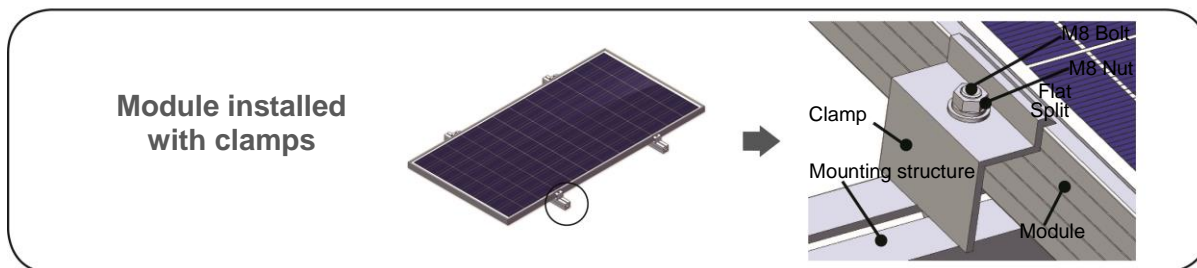
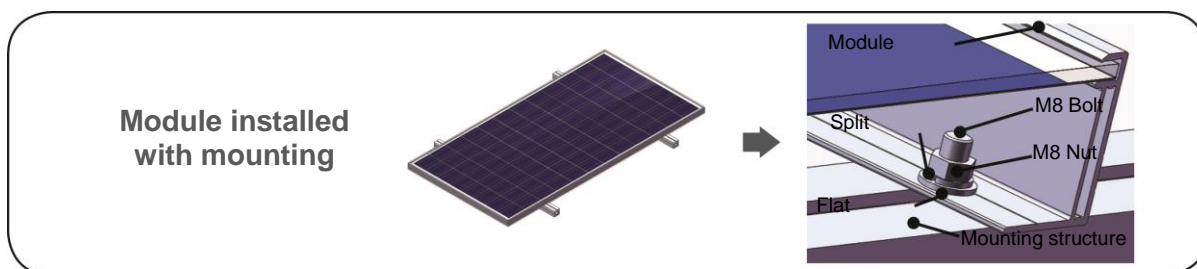

** The minimum recommended length for each clamp is 50 mm.*

Module can be installed in both landscape and portrait modes.

The modules must be properly secured to their support so that they can withstand live load conditions, including positive and negative load, to the pressure they have been certified for. It is the installer's responsibility to ensure that the clamps used to secure the modules are strong enough.

Attachment guidelines

Select the proper installation method depending on the load (See below for more detailed information).

All installation methods herein are only for reference, and Suntech will not provide related mounting components. The system installer or trained professional personnel must be responsible for the PV system's design, installation, and mechanical load calculation and security of the system.

With different installation methods, the modules have been tested to withstand the loads of 2400 Pa, 3800 Pa and 5400 Pa according to IEC 61215 standard, equivalent of 1600 Pa (0.232psi), 2500 Pa (0.363 psi) and 3600 Pa (0.522 psi) respectively under UL 1703 standard.

For each installation, modules can be installed either in portrait or landscape mode. If you integrate our obsolete products and need advice, please contact Suntech Global Customer Support Department for installation instructions based on older manuals.

Suntech Standard Module Type (using 156.75 - 157.4 mm solar cell)	Module Dimension Length x Width x Thickness
16/T Series (Full cell solar module)	1324 mm x 992 mm x 35 mm
20/W Series (Full cell solar module)	1640 mm x 992 mm x 35 mm 1650 mm x 992 mm x 35 mm
24/V Series (Full cell solar module)	1956 mm x 992 mm x 40 mm 1960 mm x 992 mm x 35 mm 1960 mm x 992 mm x 40 mm
A24/V Series (Full cell solar module)	1980 mm x 1002 mm x 35 mm
16/T Series (Half cell solar module)	1338 mm x 992 mm x 35 mm
24/V Series(Half cell solar module)	1988 mm x 992 mm x 40 mm
60/W Series (Half cell solar module)	1684 mm x 1002 mm x 35 mm
72/V Series (Half cell solar module)	2008 mm x 1002 mm x 35 mm

	2000 mm × 992 mm × 35 mm
78/V Series (Half cell solar module)	2166 mm × 992 mm × 35 mm

Suntech Standard Module Type (using 158.75 mm solar cell)	Module Dimension Length × Width × Thickness
A16/T (Half cell solar module)	1354 mm × 1002 mm × 35 mm
A20/W (Half cell solar module)	1680 mm × 1002 mm × 35 mm
A21/W (Half cell solar module)	1762 mm × 1002 mm × 35 mm
A60/W (Half cell solar module)	1684 mm × 1002 mm × 35 mm 1704 mm × 1002 mm × 35 mm
A72/V (Half cell solar module)	2008 mm × 1002 mm × 35 mm 2028 mm × 1002 mm × 35 mm
A78/V (Half cell solar module)	2178 mm × 1002 mm × 35 mm

Suntech Standard Module Type (using 166 mm solar cell)	Module Dimension Length × Width × Thickness
B60/W (Half cell solar module)	1756 mm × 1039 mm × 35 mm 1776 mm × 1052 mm × 35 mm 1791 mm × 1052 mm × 35 mm
B72/V (Half cell solar module)	2095 mm × 1039 mm × 35 mm 2115 mm × 1052 mm × 35 mm 2131 mm × 1052 mm × 35 mm
B78/V (Half cell solar module)	2204 mm × 1039 mm × 35 mm

Suntech Standard Module Type (using 182 mm solar cell)	Module Dimension Length × Width × Thickness
C54/U (Half cell solar module)	1704 mm × 1134 mm × 35 mm 1724 mm × 1134 mm × 35 mm
C66/W (Half cell solar module)	2074 mm × 1134 mm × 35 mm 2094 mm × 1134 mm × 35 mm
C72/V (Half cell solar module)	2257 mm × 1134 mm × 35 mm 2279 mm × 1134 mm × 35 mm

Suntech standard module

1) recommend mounting method

Mounting method*	Mechanical load** Note: The installation method is based on the internal results in Suntech.	Installation location	Module type
------------------	---	-----------------------	-------------

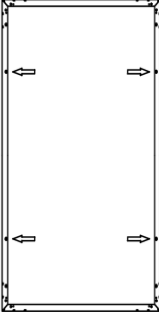
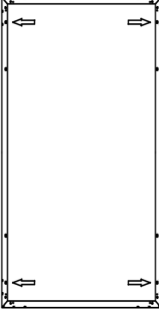
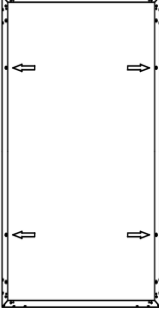
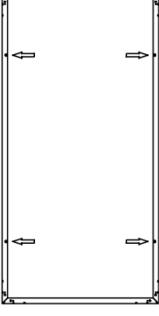
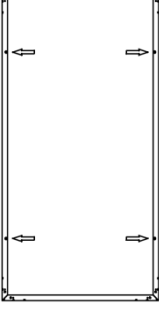
<p>4 bolts installation</p>	<p>Test load: positive 5400Pa negative 3800Pa Design load: positive 3600Pa negative 2533Pa Safety factor: 1.5</p>		<p>20/W Series C54/U Series</p>
<p>4 bolts installation</p>	<p>Test load: positive 5400Pa negative 2400Pa Design load: positive 3600Pa negative 1600Pa Safety factor: 1.5</p>		<p>60/W Series A20/W Series A21/W Series A60/W Series B60/W Series</p>
<p>4 bolts installation</p>	<p>Test load: positive 2400Pa negative 2400Pa Design load: positive 1600Pa negative 1600Pa Safety factor: 1.5</p>		<p>20/W Series 60/W Series A16/T Series A20/W Series A21/W Series A60/W Series B60/W Series</p>
<p>4 bolts installation</p>	<p>Test load: positive 5400Pa negative 3800Pa Design load: positive 3600Pa negative 2533Pa Safety factor: 1.5</p>		<p>16/T Series 24/V Series A24/V Series</p>
<p>4 bolts installation</p>	<p>Test load: positive 5400Pa negative 2400Pa Design load: positive 3600Pa negative 1600Pa Safety factor: 1.5</p>		<p>72/V Series 78/V Series A72/V Series A78/V Series B72/V Series B78/V Series C66/W Series C72/V Series</p>

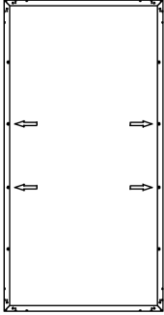
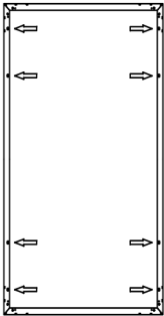
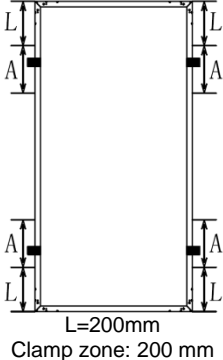
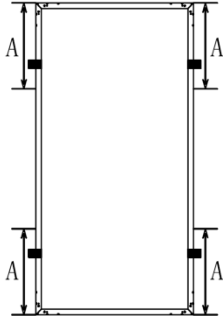
<p>4 bolts installation</p>	<p>Test load: positive 1600Pa negative 1600Pa Design load: positive 1066Pa negative 1066Pa Safety factor: 1.5</p>		<p>tracker series***</p>
<p>8 bolts installation</p>	<p>Test load: positive 5400Pa negative 3800Pa Design load: positive 3600Pa negative 2533Pa Safety factor: 1.5</p>		<p>20/W Series 60/W Series A20/W Series A21/W Series A60/W Series B60/W Series C54/U Series C66/W series</p>
<p>4 clamps installation</p>	<p>Test load: positive 6000Pa negative 3800Pa Design load: positive 4000Pa negative 2533Pa Safety factor: 1.5</p>	 <p>L=200mm Clamp zone: 200 mm</p>	<p>C54/U Series</p>
<p>4 clamps installation</p>	<p>Test load: positive 2400Pa negative 2400Pa Design load: positive 1600Pa negative 1600Pa Safety factor: 1.5</p>	 <p>Clamp zone: A=1/4 long frame length±50 mm</p>	<p>16/T Series 20/W Series 24/V Series A24/V Series 60/W Series A16/T Series A20/W Series A21/W Series A60/W Series B60/W Series</p>

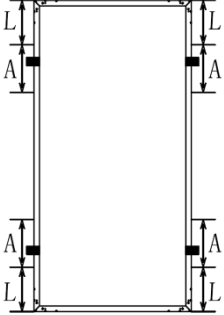
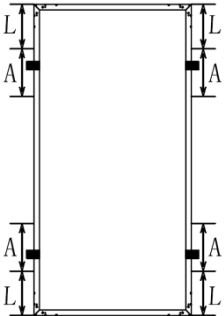
<p>4 clamps installations</p>	<p>Test load: positive 5400Pa negative 3800Pa Design load: positive 3600Pa negative 2533Pa Safety factor: 1.5</p>	 <p>16/T series L = 180 mm 20/W series L = 180 mm 24/V series L = 280 mm A16/T series L = 180 mm Clamp zone: A = 300 mm</p>	<p>16/T Series 20/W Series 24/V Series A24/V Series A16/T Series</p>
<p>4 clamps installation</p>	<p>Test load: positive 5400Pa negative 3800Pa Design load: positive 3600Pa negative 2533Pa Safety factor: 1.5</p>	 <p>21/W series L = 220 mm 60/W series L = 200 mm 72/V series L = 300 mm 78/V series L = 390 mm A20/W series L = 200 mm A21/W series L = 220 mm A60/W series L = 200 mm B60/W series L = 200 mm A72/V series L = 300 mm B72/V series L = 380 mm A78/V series L = 390 mm Clamp zone: A = 200 mm</p>	<p>60/W Series 72/V Series 78/V Series A20/W Series A21/W Series A60/W Series B60/W Series A72/V Series B72/V Series A78/V Series</p>

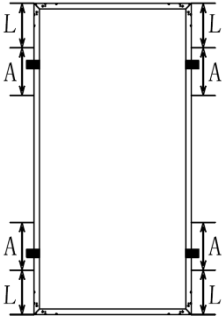
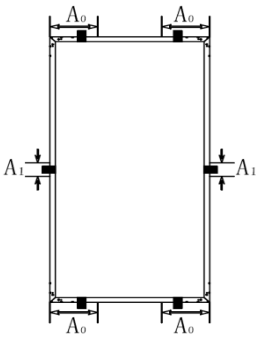
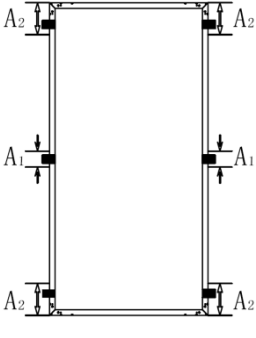
<p>4 clamps installation</p>	<p>Test load: positive 5400Pa negative 2400Pa Design load: positive 3600Pa negative 1600Pa Safety factor: 1.5</p>	 <p>B78/V series L = 490 mm C66/W series L = 280 mm C72/V* series L = 400 mm Clamp zone: A = 200 mm *Clamp zone: A = 250mm</p>	<p>B78/V Series C66/W Series C72/V Series</p>
<p>6 clamps installation</p>	<p>Test load: positive 5400Pa negative 3800Pa Design load: positive 3600Pa negative 2533Pa Safety factor: 1.5</p>	 <p>Clamp zone: $A_0 = 1/4$ short frame length ± 50 mm $A_1 = 100$ mm</p>	<p>16/T Series 20/W Series 24/V Series A24/V Series 60/W Series 72/V Series 78/V Series A16/T Series A60/W Series B60/W Series C54/U Series A72/V Series</p>
<p>6 clamps installation</p>	<p>Test load: positive 5400Pa negative 3800Pa Design load: positive 3600Pa negative 2533Pa Safety factor: 1.5</p>	 <p>Clamp zone: $A_1 = 100$ mm $A_2 = 200$ mm</p>	<p>16/T Series 20/W Series 24/V Series A24/V Series 60/W Series 72/V Series 78/V Series A16/T Series A60/W Series B60/W Series A72/V Series A78/V Series B72/V Series C54/U Series C72/V Series</p>

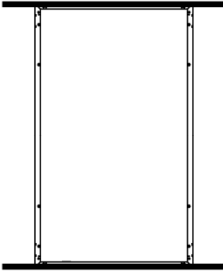
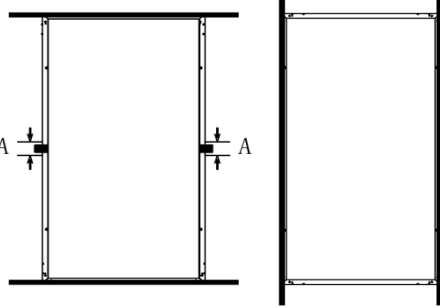
<p>Insertion installation</p>	<p>Test load: positive 2400Pa negative 2400Pa Design load: positive 1600Pa negative 1600Pa Safety factor: 1.5</p>		<p>16/T Series 20/W Series A60/W Series B60/W Series</p>
<p>Insertion installation</p>	<p>Test load: positive 5400Pa negative 3800Pa Design load: positive 3600Pa negative 2533Pa Safety factor: 1.5</p>	 <p>Clamp zone: A = 100 mm</p>	<p>16/T Series 20/W Series 24/V Series A24/V Series A60/W Series B60/W Series A72/V Series B72/V Series</p>

2) Customized mounting method

Note: The test mechanical load value are based on Suntech internal test results with specific clamps.

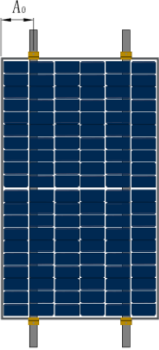
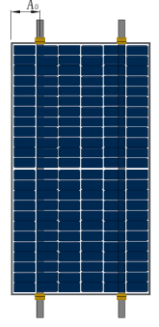
<p>Mounting method*</p>	<p>Mechanical load** Note: The installation method is based on the internal results in Suntech.</p>	<p>Installation location</p>	<p>Module type</p>
<p>4 clamps short end</p>	<p>Test load: positive 2400Pa negative 1600Pa Design load: positive 1600Pa negative 1067Pa Safety factor: 1.5</p>	 <p>$A_0 = 1/4$ short frame length ± 50mm</p>	<p>16/T Series 20/W Series 21/W Series 60/W Series 66/W Series A16/T Series A20/W Series A21/W Series A60/W Series A66/W Series B60/W Series</p>
<p>4 clamps short end</p>	<p>Test load: positive 2400Pa negative 1600Pa Design load: positive 1600Pa negative 1067Pa Safety factor: 1.5</p>	 <p>$A_0 = 1/4$ short frame length ± 50mm</p>	<p>24/V Series A24/V Series 72/V Series A72/V Series</p>

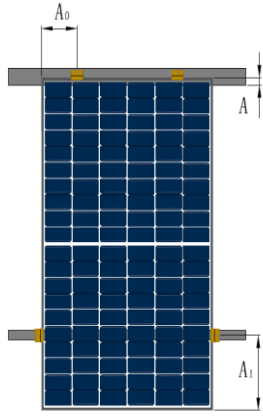
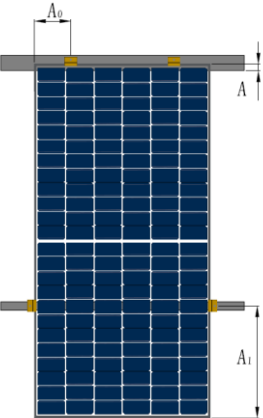
<p>4 clamps mixed mounting</p>	<p>Test load: positive 2400Pa negative 2400Pa Design load: positive 1600Pa negative 1600Pa Safety factor: 1.5</p>	 <p>$A \geq 40\text{mm};$ $A0 = 1/4 \text{ short frame length} \pm 50\text{mm};$ $A1 = 280\text{--}420\text{mm}$</p>	<p>16/T Series 20/W Series 21/W Series 60/W Series 66/W Series A16/T Series A20/W Series A21/W Series A60/W Series A66/W Series B60/W Series</p>
<p>4 clamps mixed mounting</p>	<p>Test load: positive 2400Pa negative 2400Pa Design load: positive 1600Pa negative 1600Pa Safety factor: 1.5</p>	 <p>$A \geq 40\text{mm};$ $A0 = 1/4 \text{ short frame length} \pm 50\text{mm};$ $A1 = 360\text{--}560\text{mm}$</p>	<p>24/V Series A24/V Series 72/V Series 78/V Series A72/V Series</p>

* The module clamps must not come into contact with the front glass or deform the frame in any way. Avoid shading effects from the module clamps and insertion systems. Drainage holes in the module frame must not be closed or obscured by the clamps.

** The loads of 2400 Pa, 3800 Pa and 5400 Pa are under IEC standard. The installation methods applicable for 5400 Pa are also relevant for 3800 Pa and 2400 Pa. The installation methods applicable for 3800 Pa are also relevant for 2400 Pa.

*** The mounting holes reserved for tracker mounting system with special accessories. The length of module is over 2 meters, whose load value with tracker needs to be confirmed by module supplier respectively.

Electrical Installation

Electrical property

Module under standard testing conditions of: irradiance of $1000\text{W}/\text{m}^2$, cell temperature of $25\text{ }^\circ\text{C}$ and air mass of AM1.5, maximum over-current protection is 15A.

Under normal conditions, a Photovoltaic module is likely to experience conditions that produce more current and/or voltage than reported at standard test conditions. Accordingly, the values of I_{sc} and V_{oc} marked on this module should be multiplied by a factor of 1.25 when determining component voltage ratings, conductor ampacities, fuse sizes, and size of controls connected to the PV output.

Voltages are additive when modules are connected in series, and modules currents are additive when Modules are connected in parallel, as illustrated in Figure 1.

Modules with different electrical characteristics must not be connected directly in series.

Series wiring

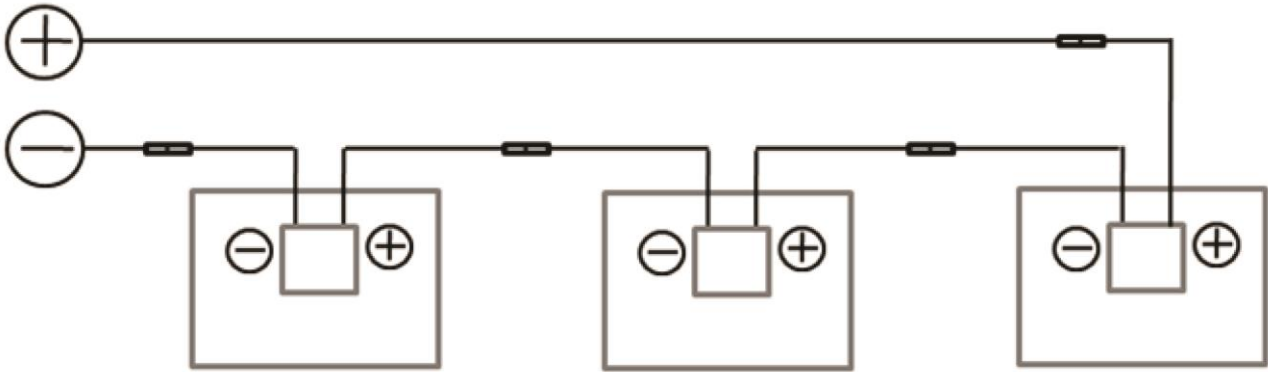

Parallel wiring

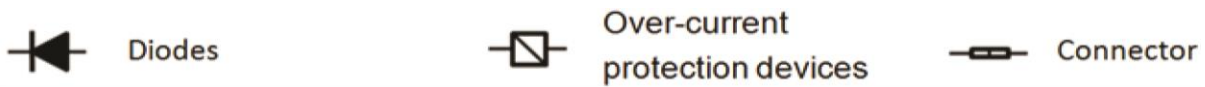
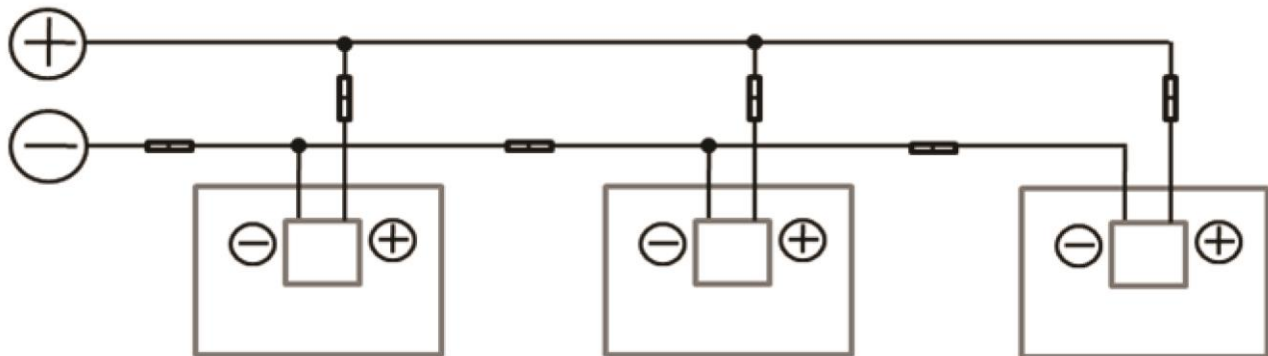

Figure 1: Electrical diagrams of series and parallel wiring.

The maximum number of Modules that can be connected in series within a string must be calculated in accordance with applicable regulations in such a way that the specified maximum system voltage (The maximum system voltage of bifacial module is DC 1500V) of the modules and all other electrical DC components will not be exceeded in open-circuit operation at the lowest temperature expected at the PV system location.

Correction factor for the open-circuit voltage can be calculated based on the following formula: $CV_{oc} = [1 - \alpha(25 - T)]\%$. T is the lowest expected ambient temperature at the system location. α (%/°C) is the temperature coefficient of the selected module V_{oc} (Refer to corresponding datasheet).

Dimension	Maximum system voltage	Maximum number of modules
1658×992×6mm	1500V	35
1968×992×6mm	1500V	29

Note: The data above are calculated based on the temperature in Wuxi. The maximum number of modules that can be connected in series within a string for the specific project must be calculated based on the actual local temperature.

If there is reverse current exceeding the maximum fuse current flowing through the module, use over-current protection device with the same specifications to protect it.

Recommended installation method of full cell solar module:

The modules in PV array are recommended for portrait connecting, and cable length is not less than 0.7 m.

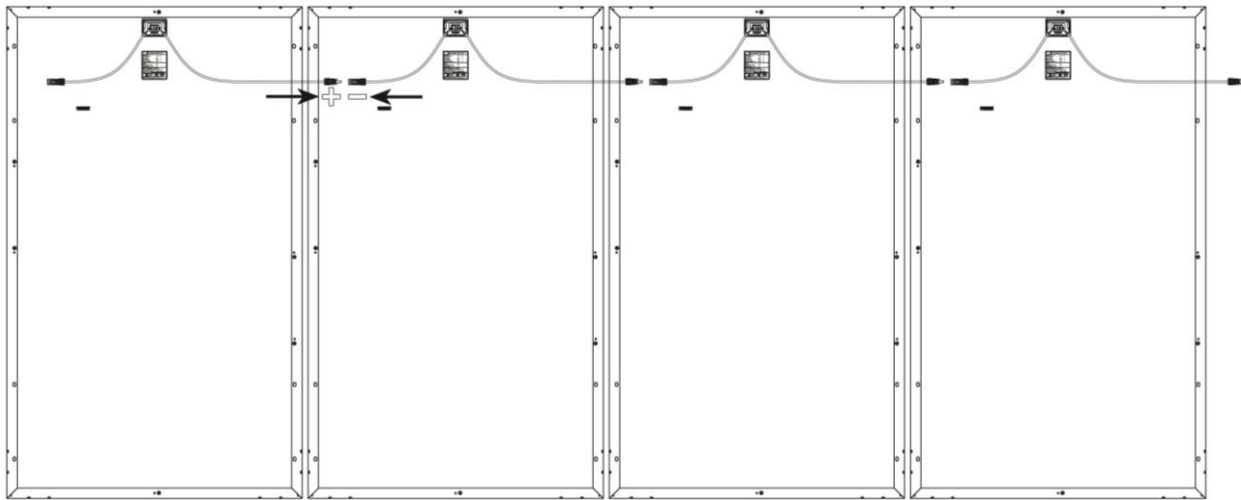

Recommended installation method of half cell solar module:

The head and tail of the modules in PV array are placed in a cross layout, and cable length is not less than 0.65 m.

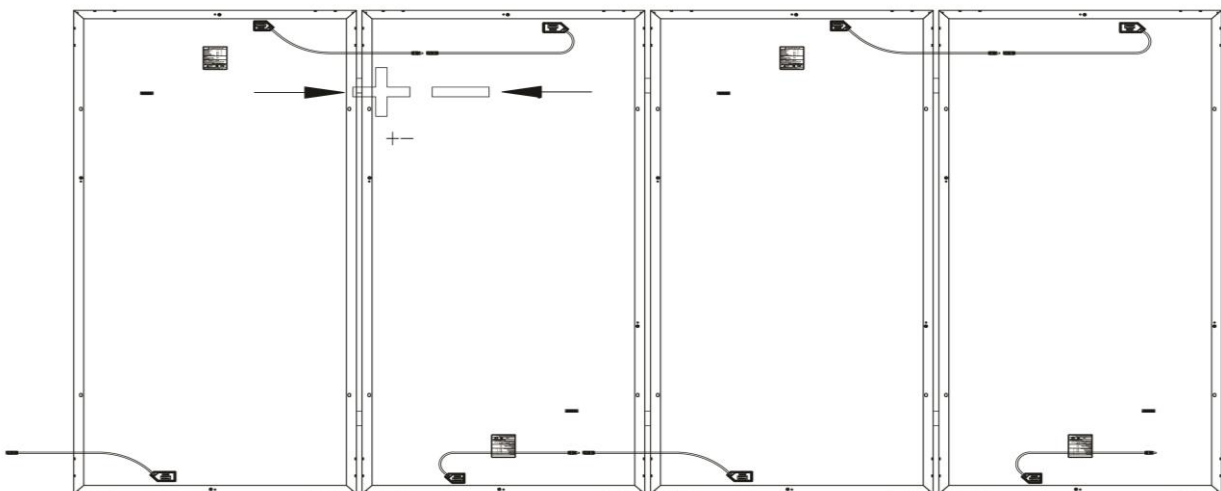

Mechanical Installation

General installation

Any hardware used must be compatible with any other used material to avoid galvanic corrosion. Defects caused by corrossions void the warranty.

It is not recommended to use modules with different configurations (grounding, wiring) in the same system.

Excessive cables must be organized or fixed in an adequate way, e.g. attached to the mounting structure by using non-metallic cable ties. Solar cables, connectors and junction boxes should not be exposed to water exposure, and snow, and rain or water submersion for a long period of time(IP65/67/68).

For applications requiring high operating voltage several modules can be connected in series to form a string of modules; the system voltage is then equal to the sum of the voltage of each module.

For applications requiring high operating currents several strings of modules can be connected in parallel; the system current is then equal to the sum of the current of each string of modules.

The maximum system voltage is 600 volts ,1000 volts or 1500 volts depending on the product family DC according to standards. The maximum number of series connected modules depends on system design, the type of inverter used and environmental conditions.

Based on the maximum series fuse rating of module and local electrical installation code, always make sure Suntech

PV modules are assembled with the appropriate string fuse for circuit protection.

There is no specific limitation on the number of modules that can be connected in parallel, the number of modules is determined by system design parameters such as current or power output.

To prevent the cables and the connectors from overheating, the cross section of the cables and the capacity of the connectors must be selected to suit the maximum system short circuit current. The recommended cable is PV wire with a cross section of at least 4mm².

Caution: do not secure the cables too tight. Any cable damage caused by cable management system is not covered under Suntech's warranty.

Always refer to the cable manufacturer's bending radius which includes the radius just behind the connectors.

When designing large modules arrays connected to a single inverter, always take into account the resulting isolation resistance (Riso), which decreases increasing the number of modules in the array. A too low Riso can result in inverter faults. Please refer to local regulations to determine the system wires size, type and temperature.

Suntech modules are supplied with connectors used for system electrical connections. The recommended connectors are TL-CABLE01S connectors, Amphenol H4 connectors, Multi Contact MC4 connectors etc. Suntech strongly recommends using the genuine connector type specified by Suntech's product data sheet. Any choice of a different connector type other than specified may void the warranty of the module.

To ensure reliable electric connection and to prevent possible intrusion of humidity, two connectors must be mated and locked together until a click can be heard.

Long-term exposure to wet environments may cause connectors' poor connectivity, resulting in current leakage and poor conductivity which voids the warranty. Suntech recommends proper connector/cable/wire management to prevent moisture intrusion. Depending on the amount of humidity, Suntech recommends periodic inspections of the installation system to maintain optimal module performance.

The DC current generated by photovoltaic systems can be converted into AC and fed into a public Grid. As local utilities' policies on connecting renewable energy systems to the Grids vary from region to region. Always seek the advice from a qualified system designer or integrator. Building permits, inspections and approvals by the local utility are generally required.

Especially for larger installations Suntech recommends lightning protection following the local requirements and regulations.

When the installation finished and after connecting to the grid, please do a professional hand over to the owner including an installation protocol is required. Provide a clear documentation of the system to the owner consisting of following minimum data such as: user guide, system layout, data sheets, performance expectations, electrical system data e.g. a copy of the installation test report following minimum requirements of IEC 62446 / IEC 60364-6.

Grounding

For grounding and bonding requirements, please refer to regional and national safety and electricity standards. If grounding is required, use a recommended connector type for the grounding wire.

For grounding, this guide refers to module frame grounding. If grounding is required, make sure module frames (metal exposed to touch) are always grounded.

Suntech recommends always refer to local state and national code requirements for PV module grounding. Suntech highly recommends negative grounding if it's allowed by local authorities.

When attaching the frame grounding hardware and wire to the frame it must be placed corresponding to the ground symbol stamped location to ensure proper electrical connection.

Suntech recommends one of the following parts for grounding:

1) Use M5 bolt and washer to bond the ground wire and aluminum frame through the grounding hole (as shown below). The tightening torque is 3-7Nm. All nuts and washers should be made of stainless steel. 4-14 mm² (AWG 6-12) exposed copper wire recommended as ground wire.

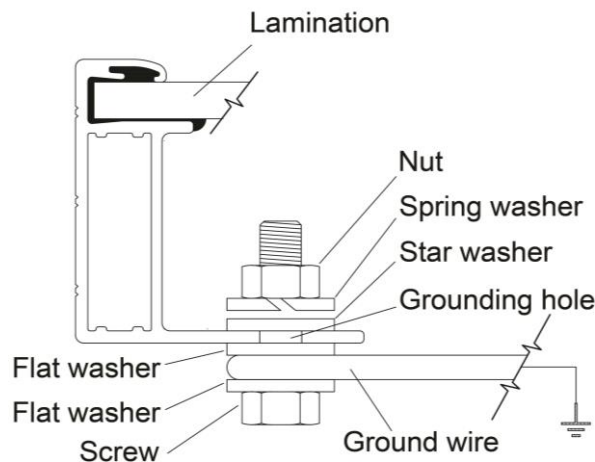

2) Use WEEB-DPF to bond solar modules to module mounting brackets (grounding part is tested to UL467)

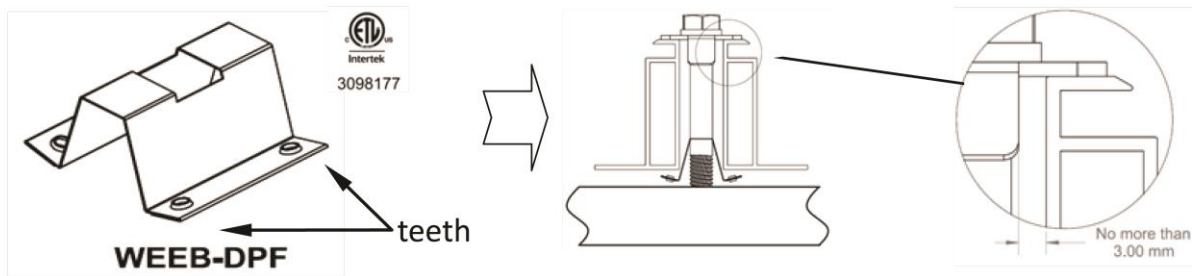

Notice that WEEB tooth is positioned completely under the edge of the module frame.

When position of solar module is finalized, torque fasteners to 20.5 N-m/15 ft-lb using general purpose anti-seize on threads.

For more information, please contact supplier: BURNDY, <http://www.we-llc.com>

3) Use Schletter clamps to bond solar module to module mounting brackets (grounding part is tested to UL467).

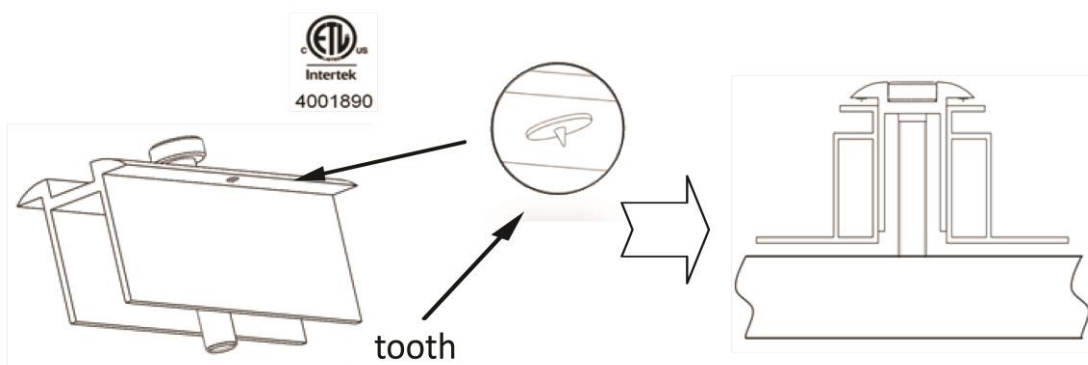

Recommend fastening torque is 20.5N-m/15 ft-lb.

For more information, please contact supplier: Schletter, <http://www.solar.schletter.eu>

Maintenance

To ensure optimum module performance, Suntech recommends the following maintenance measures:

Clean the module minimum once a year or more often when required depending of the pollution. Remove all organic from the surface. Module with soiling or contamination may reduce the power generation of the system. Always use clean water and a soft non-abrasive sponge or cloth for cleaning. A mild, non-abrasive cleaning agent may be used to remove stubborn dirt.

Uncontrolled pollution is voiding the warranty or not cleaning the modules in time voids the warranty.

Check the electrical, grounding and mechanical connections every six months to verify that they are clean, secure, undamaged and free of corrosion. Or else the warranty may be voided.

In the event of a ground fault condition, NEVER wash or spray modules with water until ground fault has been identified, corrected by an authorized solar inverter service technician and the inverter is fully operational. This can cause electrocution or a serious safety issue.

If any problem arises, consult a professional solar service provider for suggestions.

Caution: observe solar manufacturers' maintenance instructions for all components used in the system, such as support frames, charging regulators, inverters, batteries etc.

目录

安全指南	15
总体安全	
操作安全	
安装安全	
消防安全	
产品鉴别	16
机械安装	16
场地选择	
常规安装	
安装方式	
安装指南	
电气安装	23
常规安装	
接地	
维护	25

*请仔细阅读。该文件对任何保修情况都具有约束力。

*距海岸线 500 米内安装光伏系统，请参考近海安装手册。

安全指南

本指南包含有关无锡尚德太阳能电力有限公司光伏组件（以下简称为“组件”）的安装方式和安全操作的相关信息。无锡尚德太阳能电力有限公司简称为“尚德”。

安装人员在安装前必须阅读并理解该指南。如有任何问题，请联系尚德全球质量与客户支持部门或我们当地代表获得更详细的信息。安装人员必须遵循本指南中说明的所有安全预防措施、当地要求和法律或授权机构的规定。

在安装太阳能光伏系统前，安装人员应当熟悉其机械和电气要求。将本指南存放于安全处用于日后参考（维护和保养）以及在将组件出售或处理时使用。

尚德组件通过了全球检测和认证机构的测试。不同地区的光伏太阳能组件的安装有不同规定。其中通过“IEC”认证的组件适用于欧洲、中东及大部分亚太国家；通过“UL”认证的组件适用于美国、加拿大；其余的全球通用。

总体安全

组件适用于大于50伏直流电压或240瓦功率以上的系统，通过IEC 61730-2标准即符合安全等级II才可以用于安全安装（仅IEC）。

光伏组件推荐安装海拔不超过2000米。

安装光伏系统需要专业技术和知识。安装只能由有资质的人员进行。

安装人员必须承担所有在安装过程中可能出现的危险，包括但不限于电击危险。

单块组件在阳光直射的条件下可产生超过30伏的直流电。与直流电接触有很高的潜在风险，请在任何情况下都避免接触直流电。

请勿在工作状态下断开组件和任何电器件的连接。

光伏组件通过阳光照射可以产生电流。许多组件串联可能导致致命的触电和灼伤危害。只有经过授权和培训的专业人员才能进行组件的安装工作。

光伏组件将光能转化成直流电能，它们适用于户外安装。组件可以安装在地面或屋顶上。系统设计师和安装人员负责支撑结构的合理设计。

安装系统时，须遵守所有当地、地区性和国家级的法定法规。如有必要，请取得安装许可证。

组件在标准测试条件下，铭牌所标称的电性能参数与实际值有 $\pm 3\%$ 的偏差。（辐照度1000 W/m²，AM 1.5光谱，电池温度为25 °C (77 °F)）。

光伏发电系统只能使用与之相匹配的设备、连接器、接线和支架。

请勿使用反光镜或其他放大镜将阳光直接聚焦于组件上。

在183 cm或更高处作业时必须有防坠落保护措施。遵守职业安全和健康法案（OSHA）或当地有关坠落保护的安全规定（仅UL）。

请勿坐于、站立于、踩踏或行走于组件之上，包括支架。

除自然降雨或者阶段性组件清洗外，请勿将组件的任何部位浸泡在水中或者持续用水冲击组件。

操作安全

请勿抓住组件接线盒或引出线提起组件。

请勿使组件掉落或使物体坠落于组件上。

请勿在组件上放置任何重物或尖锐物体。

组件要轻拿轻放。

不恰当的运输或安装可能损坏组件并使质保无效。

请勿拆解组件及组件上的铭牌。

请勿在组件玻璃或背板上使用油漆或粘合剂。

为避免损坏背板和电池，请勿刮擦、撞击或使背板产生凹痕。运输时，请勿直接施压于组件的背板或玻璃。

请勿在边框上钻孔。这可能破坏边框的强度，导致边框生锈并使质保无效。

请勿刮擦支架的阳极处理层（除了组件背面接地连接点的接地连接处）。这可能导致边框生锈或破坏边框的强度。

组件破损后将无法修复并可能导致触电，禁止使用已损坏的组件，如已有损坏的玻璃或背板等。

只能在干燥环境中作业，且只能使用干燥的工具。请勿在未佩戴任何保护措施的条件下在潮湿的环境中作业。

如需在户外将未安装的组件存放一段时间，须始终遮盖组件并保证玻璃面向下且置于柔软平面上，防止组件内部积水和连接器的损坏。

安装安全

请勿在电路有负载的情况下打开电气连接处或拔出连接器。

如果触碰组件带电零部件，例如连接器，无论面板是否已接通，可能导致烧伤、火星和致命电击。

在安装过程中请勿在不必要时触碰组件。玻璃表面和支架可能有产生高温；会产生烧伤和电击危险。

请勿在下雨、下雪或大风天气情况下安装组件。

为防止组件绝缘效果降低，请避免刮擦、切割电缆和连接器或使其长期暴露在阳光下。

只能使用符合相关电气安装标准的绝缘工具。

运输和安装相关组件时请使儿童远离该系统。

安装时使用不透明材料将组件完全盖住，防止产生电损。

安装或修理光伏系统时请勿佩戴金属戒指、腕表、耳环、鼻环、唇环或其它金属物质。

遵守当地的安全规定（例如，关于操作发电站的安全规定）和关于系统其它部件，包括接线和电缆、连接器、充电调节器、逆变器、蓄电池、可充电的电池等的安全规定。

正常情况下，一块光伏组件产生的电流和/或电压可能比标准试验条件下产生的多。因此在计算组件额定电压、额定电流、保险熔断和连接至PV输出的控件规格时，应当将标记在该组件上的Isc和Voc的值乘以1.25的系数。

连接组件时只能使用相同型号的连接器连接到其它设备上。将连接器移除将使质保无效。

安全指南

消防安全

咨询您当地的部门获得关于安装或建筑消防安全方面的指导和要求。
顶层结构和安装可能影响建筑的消防安全；不恰当的安装可能导致火灾危险。
在当地部门要求下，使用例如接地故障断路器 and 保险丝之类的设备。
请勿在可能产生可燃性气体的环境中或设备附近操作面板。
该组件的防火等级为C，适合安装于类别A的屋顶上。

产品鉴别

每个组件有三个标签，提供下列信息：

1. 铭牌，说明了产品类型；额定功率、额定电流、额定电压、开路电压、短路电流，重量、尺寸等所有数值均在标准检测条件下测量得出；对于UL标准而言，系统最大电压为600伏、1000伏和1500伏，取决于组件的直流电流，对于IEC标准而言为1000伏和1500伏直流电压。有些UL/IEC产品表示其最大电压为1000伏和1500伏，而其它UL产品为600伏。检查您的产品铭牌或联系您的当地代表获得详细信息。
2. 条形码：每个单一的组件有一个专属的序列号。该序列号有18位数字。第15位和第16位是周数编码，第17位和第18位是年份编码。例如，STP xxxxxxxxxxxx2414 表示组件在2014年第24周组装和检测。每个组件只有一个条形码。它将永远黏贴在组件内部，并且可以从组件前部顶端看到。该条形码在层压前被插入。



条形码标签

3. 分档标签：该标签上显示了四个不同的标志。“QC Pass”确保组件已通过了质量控制检查。“HIPOT”表示已通过了绝缘测试。最后根据组件的输出电流将组件筛选，由相应的“ I_x ”符号表示，其中x表示值1、2和3为使组件串获得最优性能，建议只在一个串中选用“ I_x ”类别相同的组件，（例如只有 I_2 组件）。“条形码”的作用请参考上述“条形码”介绍。



分档标签

请勿取下任何标签。取下任一张标签将导致尚德质保无效。

机械安装

场地选择

为组件的安装选择合适的场地。

组件在北纬下应面朝南，南纬下面朝北。

如需关于最佳安装角度的详细信息，请参考标准太阳能光伏安装指南或咨询专业太阳能安装人员和系统集成商。

组件在任何时间都不应被阳光遮挡。如果整个或部分组件被遮挡，它将无法在理想条件下发挥性能并导致较低的功率输出。组件持久或经常性地被遮挡住阳光将损坏组件并使质保无效。

本安装手册适用于所有离海岸线500米或以上距离的光伏系统的安装。如果您需要将系统安装于离海岸线500米以内的距离，请参考近海安装手册（www.suntech-power.com）或者联系尚德全球质量& 客户支持部门以及我们的地区代表。

请勿在可能产生或收集易燃气体的设备附近或场所中使用组件。

常规安装

安装前请仔细检查光学偏差。任何在系统安装完成后出现的光学偏差都有可能使质保无效。一旦出现，任何潜在的花费诸如人工费、材料费、文件编制费、人员安全以及消除光学偏差产生的费用都不在尚德的质保范围内。

组件的支撑结构必须使用耐用、防锈和抗紫外材料制作。请使用经检测和认证批准的支撑结构。

在冬天有大量降雪的地区，请选择合适的支撑系统高度，使组件最低边缘在任何时候都不会被雪覆盖。另外，请保证组件最低部分放置的高度足够，使植物、树木不会遮挡住阳光。

对于地面安装系统，尚德建议地面离组件底部的最小距离至少为60厘米。

组件必须稳固放置在支撑结构上。如使用夹带夹具的安装方式，每个夹具的建议最大压强为20Mpa，以防止对组件支架造成损坏。请遵守夹具系统供应商的说明。

根据您当地的规定为组件底部提供充足的通风。屋顶平面与组件的支架之间通常建议应有最少10厘米的距离。

始终遵守组件支架的说明指导和安全防范措施。

将组件安装于屋顶前，请确保屋顶的结构合理。另外，任何需要安装组件的屋顶必须密封处理防止漏水。

组件表面上积聚的灰尘可能破坏组件性能。安装组件的倾斜角度不宜低于10°，以便灰尘被雨水冲刷。倾斜角度过小组件需要更频繁清洗。

两个组件间的距离建议最少为2厘米，防止热膨胀产生的损坏。

将组件安装于立柱上时，选择的立柱和组件支撑结构必须可以承受当地可能的风载荷和雪载荷。

确保组件不会承受超过最大允许载荷的风载和雪载，而且不会承受支撑结构热膨胀产生力。不允许组件重叠或者超出屋顶。请参考下列安装方式获得详细信息。

安装方式

组件可以使用安装孔、夹具*或滑槽被安装在支架上，建议的安装扭矩20Nm-25Nm。必须根据下列样例安装组件。没有根据下列说明安装组件，会使质保无效。

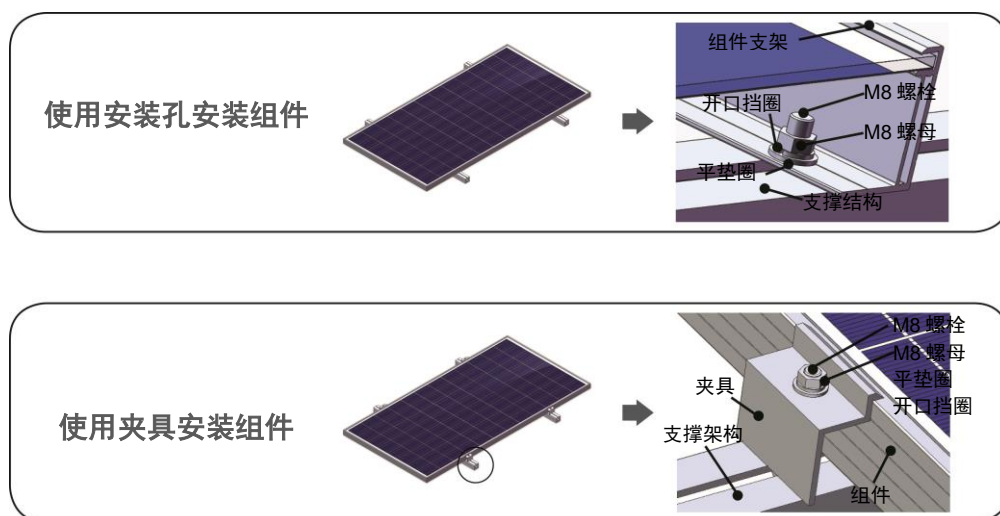

***每个夹具最小建议长度为50 mm**

组件可以采用横向和纵向安装。

组件必须稳固固定在支架上，以便承受相应的正负压。安装人员必须负责确保用于固定组件的夹具有足够的强度。

安装指南

根据载荷需求选择合适的安装方法（参考下文获得更详细信息）。

经检测，使用不同的安装方法时，组件可以承受2400 Pa、3800 Pa和5400 Pa的载荷，（IEC61215标准）分别等同于UL1703标准下的1600 Pa (0.232psi)、2500 Pa (0.363psi) 和3600 Pa (0.522psi)。

下表中的图示仅供参考，尚德不提供任何相关安装相关部件，安装商或经过培训的专业人员必须对光伏系统的设计，安装和当地的载荷值计算和安全等负责。

对于每种安装方法，组件均可纵向或横向安装。如果曾安装尚德的旧组件需要咨询，请联系尚德全球质量&客户支持部门获取旧的安装说明以作为参考。

尚德组件型号 (使用156.75 - 157.4 mm电池片)	组件尺寸 (长×宽×厚)
16/T系列 (全片组件)	1324 mm × 992 mm × 35 mm
20/W系列 (全片组件)	1640 mm × 992 mm × 35 mm 1650 mm × 992 mm × 35 mm
24/V系列 (全片组件)	1956 mm × 992 mm × 40 mm 1960 mm × 992 mm × 35 mm 1960 mm × 992 mm × 40 mm
A24/V系列 (全片组件)	1980 mm × 1002 mm × 35 mm
16/T系列 (半片组件)	1338 mm × 992 mm × 35 mm
24/V系列 (半片组件)	1988 mm × 992 mm × 40 mm
60/W系列 (半片组件)	1684 mm × 1002 mm × 35 mm
72/V系列 (半片组件)	2008 mm × 1002 mm × 35 mm 2000 mm × 992 mm × 35 mm
78/V系列 (半片组件)	2166 mm × 992 mm × 35 mm

尚德组件型号 (使用158.75 mm电池片)	组件尺寸 (长×宽×厚)
A16/T系列 (半片组件)	1354 mm × 1002 mm × 35 mm
A20/W系列 (半片组件)	1680 mm × 1002 mm × 35 mm
A21/W系列 (半片组件)	1762 mm × 1002 mm × 35 mm
A60/W系列 (半片组件)	1684 mm × 1002 mm × 35 mm 1704 mm × 1002 mm × 35 mm
A72/V系列 (半片组件)	2008 mm × 1002 mm × 35 mm 2028 mm × 1002 mm × 35 mm
A78/V系列 (半片组件)	2178 mm × 1002 mm × 35 mm

尚德组件型号 (使用166 mm电池片)	组件尺寸 (长×宽×厚)
B60/W系列 (半片组件)	1756 mm × 1039 mm × 35 mm 1791 mm × 1052 mm × 35 mm
B72/V系列 (半片组件)	2095 mm × 1039 mm × 35 mm 2131 mm × 1052 mm × 35 mm
B78/V系列 (半片组件)	2204 mm × 1039 mm × 35 mm

尚德组件型号 (使用182 mm电池片)	组件尺寸 (长×宽×厚)
C54/U系列 (半片组件)	1704 mm × 1134 mm × 35 mm 1724 mm × 1134 mm × 35 mm
C66/V系列 (半片组件)	2074 mm × 1134 mm × 35 mm 2094 mm × 1134 mm × 35 mm
C72/V系列 (半片组件)	2257 mm × 1134 mm × 35 mm 2279 mm × 1134 mm × 35 mm

尚德常规标准组件

1) 常规安装方式

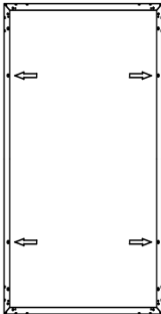
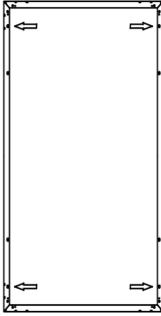
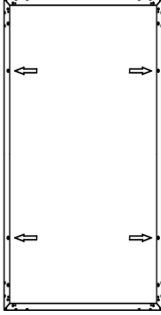
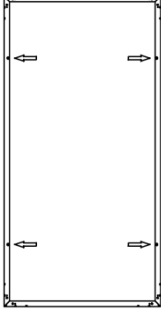
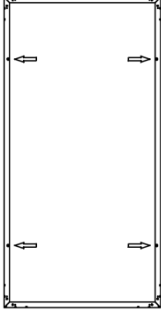
安装类型*	适用载荷** 以下载荷值仅是基于尚德内部的测试结果	安装图示	适应版型
四螺栓安装	测试载荷: 正压 5400Pa/负压 3800Pa 设计载荷: 正压 3600Pa/负压 2533Pa 安全系数 1.5		20/W 系列 C54/U 系列
四螺栓安装	测试载荷: 正压 5400Pa/负压 2400Pa 设计载荷: 正压 3600Pa/负压 1600Pa 安全系数 1.5		60/W 系列 A20/W 系列 A21/W 系列 A60/W 系列 B60/W 系列
四螺栓安装	测试载荷: 正压 2400Pa/负压 2400Pa 设计载荷: 正压 1600Pa/负压 1600Pa 安全系数 1.5		20/W 系列 60/W 系列 A16/T 系列 A20/W 系列 A21/W 系列 A60/W 系列 B60/W 系列
四螺栓安装	测试载荷: 正压 5400Pa/负压 3800Pa 设计载荷: 正压 3600Pa/负压 2533Pa 安全系数 1.5		16/T 系列 24/V 系列 A24/V 系列
四螺栓安装	测试载荷: 正压 5400Pa/负压 2400Pa 设计载荷: 正压 3600Pa/负压 1600Pa 安全系数 1.5		72/V 系列 78/V 系列 A72/V 系列 B72/V 系列 A78/V 系列 B78/V 系列 C66/W 系列 C72/V 系列

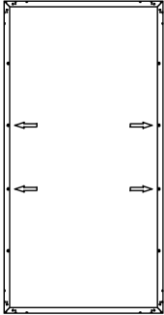
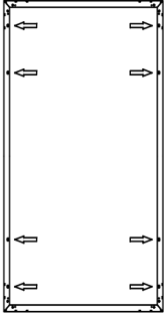
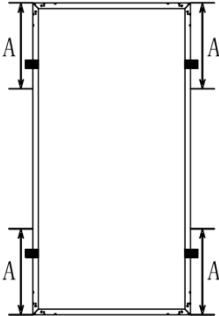
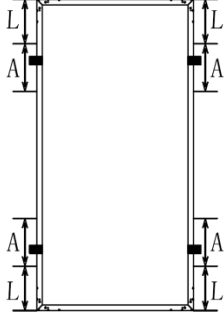
<p>四螺栓安装</p>	<p>测试载荷: 正压 1600Pa/负压 1600Pa 设计载荷: 正压 1066Pa/负压 1066Pa 安全系数 1.5</p>		<p>Tracker 系列***</p>
<p>八螺栓安装</p>	<p>测试载荷: 正压 5400Pa/负压 3800Pa 设计载荷: 正压 3600Pa/负压 2533Pa 安全系数 1.5</p>		<p>20/W 系列 60/W 系列 A20/W 系列 A21/W 系列 A60/W 系列 B60/W 系列 C54/U 系列</p>
<p>四夹具安装</p>	<p>测试载荷: 正压 2400Pa/负压 2400Pa 设计载荷: 正压 1600Pa/负压 1600Pa 安全系数 1.5</p>	 <p>夹具区: $A = 1/4$长边框长度 ± 50 mm</p>	<p>16/T 系列 20/W 系列 24/V 系列 A24/V 系列 60/W 系列 A16/T 系列 A20/W 系列 A21/W 系列 A60/W 系列 B60/W 系列</p>
<p>四夹具安装</p>	<p>测试载荷: 正压 6000Pa/负压 3800Pa 设计载荷: 正压 4000Pa/负压 2533Pa 安全系数 1.5</p>	 <p>$L=200$mm 夹具区: $A = 200$ mm</p>	<p>C54/U 系列</p>

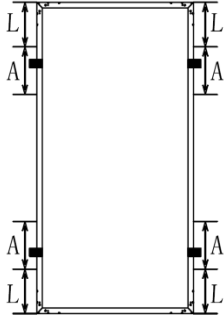
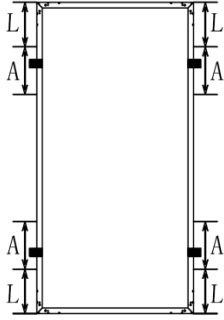
<p>四夹具安装</p>	<p>测试载荷: 正压 5400Pa/负压 3800Pa 设计载荷: 正压 3600Pa/负压 2533Pa 安全系数 1.5</p>	 <p>16/T系列 L = 180 mm 20/W系列 L = 180 mm 24/V系列 L = 280 mm A16/T系列 L = 180 mm 夹具区: A = 300 mm</p>	<p>16/T 系列 20/W 系列 24/V 系列 A24/V 系列 A16/T 系列</p>
<p>四夹具安装</p>	<p>测试载荷: 正压 5400Pa/负压 3800Pa 设计载荷: 正压 3600Pa/负压 2533Pa 安全系数 1.5</p>	 <p>60/W系列 L = 200 mm 72/V系列 L = 300 mm 78/V系列 L = 390 mm A20/W系列 L = 200 mm A21/W系列 L = 220 mm A60/W系列 L = 200 mm B60/W系列 L = 200 mm A72/V系列 L = 300 mm B72/V系列 L = 380 mm A78/V系列 L = 390 mm 夹具区: A = 200 mm</p>	<p>60/W 系列 72/V 系列 78/V 系列 A20/W 系列 A21/W 系列 A60/W 系列 B60/W 系列 A72/V 系列 B72/V 系列 A78/V 系列</p>

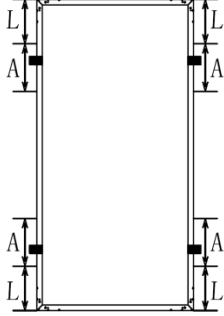
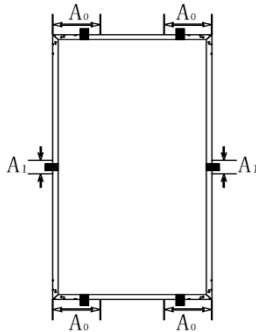
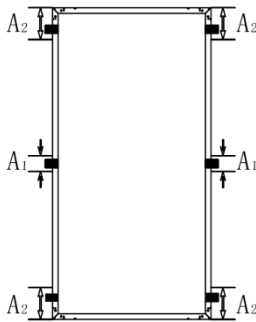
<p>四夹具安装</p>	<p>测试载荷: 正压 5400Pa/负压 2400Pa 设计载荷: 正压 3600Pa/负压 1600Pa 安全系数 1.5</p>	 <p>B78/V系列 L = 490 mm C66/W系列 L = 280 mm C72/V系列* L = 400 mm 夹具区: A = 200 mm *夹具区: A = 250 mm</p>	<p>B78/V 系列 C66/W 系列 C72/V 系列</p>
<p>六夹具安装</p>	<p>测试载荷: 正压 5400Pa/负压 3800Pa 设计载荷: 正压 3600Pa/负压 2533Pa 安全系数 1.5</p>	 <p>夹具区: $A_0 = 1/4$短边框长度 ± 50 mm $A_1 = 100$ mm</p>	<p>16/T 系列 20/W 系列 24/V 系列 A24/V 系列 60/W 系列 72/V 系列 78/V 系列 A16/T 系列 A20/W 系列 A21/W 系列 A60/W 系列 C54/U 系列 A72/V 系列 A78/V 系列</p>
<p>六夹具安装</p>	<p>测试载荷: 正压 5400Pa/负压 3800Pa 设计载荷: 正压 3600Pa/负压 2533Pa 安全系数 1.5</p>	 <p>夹具区: $A_1 = 100$ mm $A_2 = 200$ mm</p>	<p>16/T 系列 20/W 系列 24/V 系列 A24/V 系列 60/W 系列 72/V 系列 78/V 系列 A16/T 系列 A20/W 系列 A21/W 系列 A60/W 系列 B60/W 系列 C54/U 系列 A72/V 系列 B72/V 系列</p>

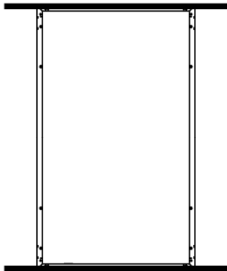
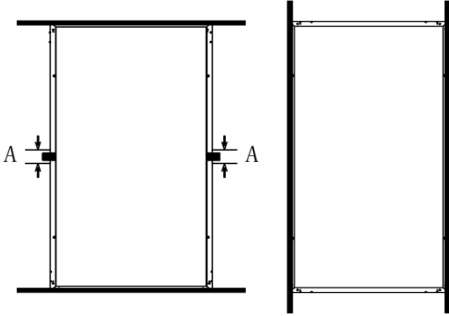
			A78/V 系列
滑槽安装	测试载荷: 正压 2400Pa/负压 2400Pa 设计载荷: 正压 1600Pa/负压 1600Pa 安全系数 1.5		16/T 系列 20/W 系列
滑槽安装	测试载荷: 正压 5400Pa/负压 3800Pa 设计载荷: 正压 3600Pa/负压 2533Pa 安全系数 1.5	 夹具区: A = 100mm	16/T 系列 20/W 系列 24/V 系列 A24/V 系列 A60/W 系列 B60/W 系列 A72/V 系列 B72/V 系列

客户定制化安装方式

注: 以下所列出的载荷值基于尚德使用具体的压块安装后的测试值。

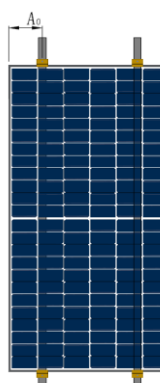
安装类型*	适用载荷** 以下载荷值仅是基于尚德内部的测试结果	安装图示	适应版型
四压块 短边安装	测试载荷: 正压 2400Pa/负压 1600Pa 设计载荷: 正压 1600Pa/负压 1067Pa 安全系数 1.5	 A0=1/4 短边框长度±50mm	16/T 系列 20/W 系列 21/W 系列 60/W 系列 66/W 系列 A16/T 系列 A20/W 系列 A21/W 系列 A60/W 系列 A66/W 系列 B60/W 系列 C54/U 系列
四压块 短边安装	测试载荷: 正压 2400Pa/负压 1600Pa 设计载荷: 正压 1600Pa/负压 1067Pa 安全系数 1.5	 A0=1/4 短边框长度±50mm	24/V 系列 72/V 系列 A24/V 系列 A72/V 系列

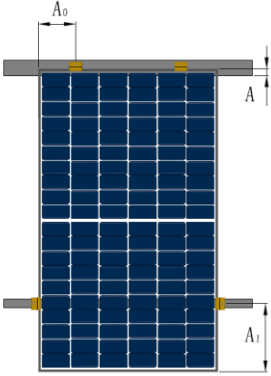
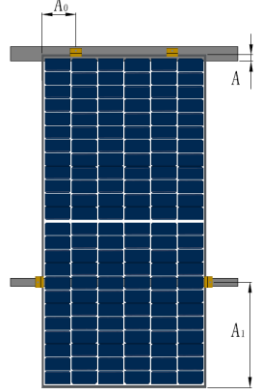
<p>四压块混合安装</p>	<p>测试载荷: 正压 2400Pa/负压 2400Pa 设计载荷: 正压 1600Pa/负压 1600Pa 安全系数 1.5</p>	 <p>$A \geq 40\text{mm}$; $A_0 = 1/\text{短边框长度} \pm 50\text{mm}$; $A_1 = 280\text{--}420\text{mm}$</p>	<p>16/T 系列 20/W 系列 21/W 系列 60/W 系列 66/W 系列 A16/T 系列 A20/W 系列 A21/W 系列 A60/W 系列 A66/W 系列 B60/W 系列 C54/U 系列</p>
<p>四压块混合安装</p>	<p>测试载荷: 正压 2400Pa/负压 2400Pa 设计载荷: 正压 1600Pa/负压 1600Pa 安全系数 1.5</p>	 <p>$A \geq 40\text{mm}$; $A_0 = 1/4 \text{ 短边边框长度} \pm 50\text{mm}$; $A_1 = 360\text{--}560\text{mm}$</p>	<p>24/V 系列 72/V 系列 78/V 系列 A24/V 系列 A72/V 系列</p>

*任何情况下，组件夹具都不能触碰到前端玻璃或使支架变形，以避免组件夹具和滑槽遮挡电池片。夹具不能封住或盖住组件支架上的排水孔。

** 2400 Pa、3800 Pa和5400 Pa为IEC标准下的载荷。适用于5400 Pa的安装方式可覆盖3800 Pa和2400 Pa。适用于3800 Pa的安装方式可覆盖2400 Pa。

***安装孔位为tracker单轴安装支架预留，需搭配tracker专用配件安装使用，长度超过2米的组件，该安装方式的载荷值需要单独计算。

尚德全片组件推荐连接方式：

方阵内组件横向安装，组件线长：正负极线长不小于0.7 m。

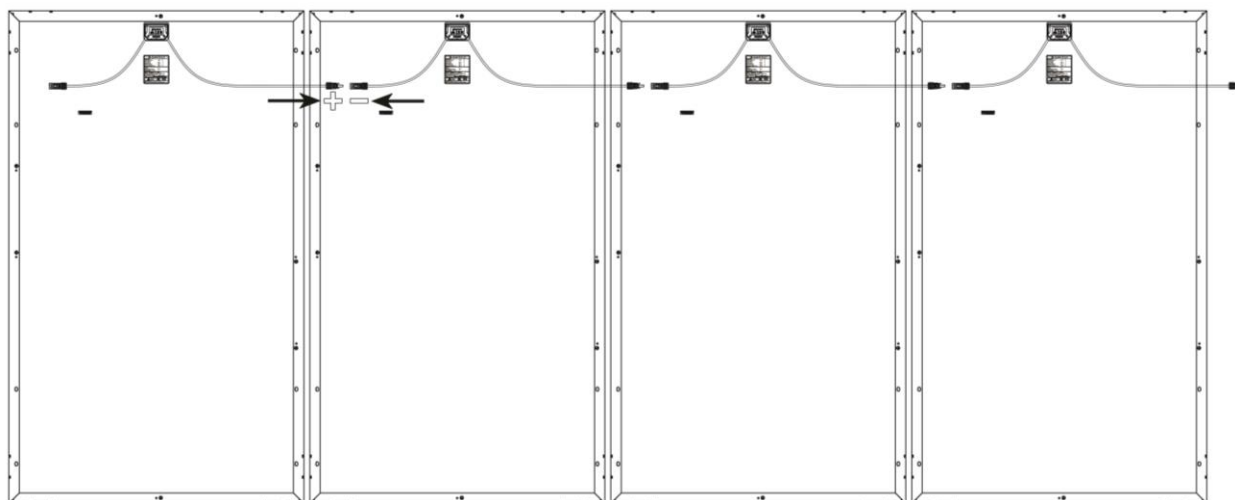

尚德半片组件推荐连接方式：

方阵内组件头尾方向处于交叉布置，组件线长：正负极线长不小于0.65 m。

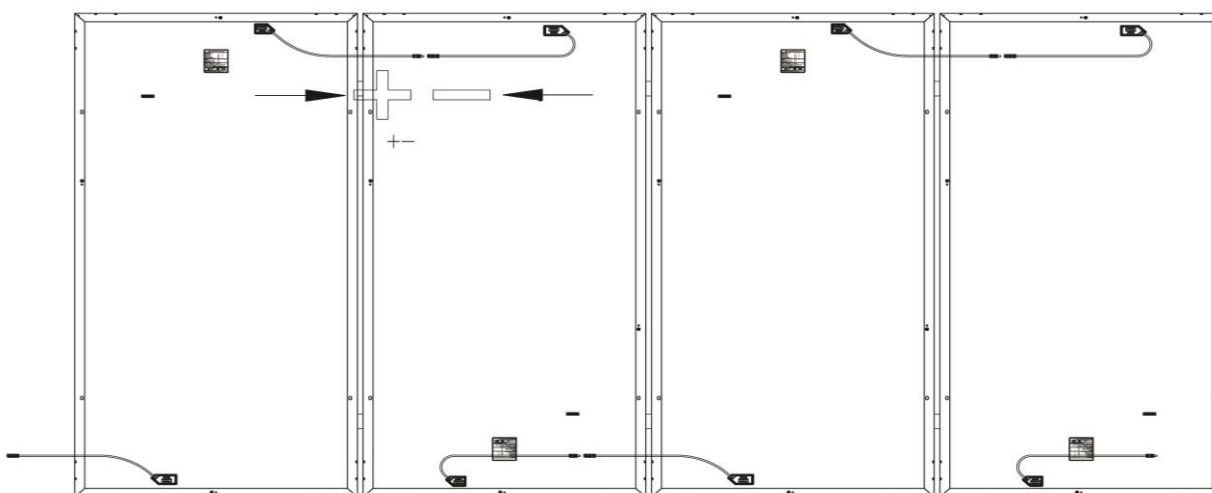

电气安装

常规安装

任何所使用的安装附件必须在材料上相互兼容，避免电化学腐蚀。由于腐蚀引起的故障将导致质保无效。

不建议在同一个系统中使用配置不同的组件。

必须将多余的电缆整理或充分固定，例如，使用非金属绑线将其固定在支架上。组件电缆线、连接器和接线盒不应长时间接触水、雨雪或浸泡于水中(IP65/67/68)。

对于需要高操作电压的应用而言，可以将多个组件串联形成组件串；系统电压即等同于每个组件的电压的总和。

对于需要高操作电流的应用而言，可以将多个组件串并联；系统电流即等同于每个组件串的电流总和。

根据标准，组件的最大系统电压为600伏或1000伏或1500伏。

串联连接的组件最大数目由系统设计、所用的逆变器类型和环境条件决定。

根据组件最大串联保险丝额定值和当地电气安装规范，如果尚德光伏组件并联，需要装配合适的串保险丝。

对于并联连接的组件没有数量上的特殊限制，组件的数量由系统设计参数，例如电流或功率输出决定。

为防止电缆和连接器过热，必须选择适合系统最大短路电流的电缆线和连接器。推荐电缆是横截面至少4mm²的光伏电缆线。

注意：请勿让电缆线承受过大压力。任何由于电缆线连接导致的损坏不在尚德的质量保证范围内。

请遵守电缆线厂商推荐的弯曲半径，包含连接器后的电缆半径。

请参考当地规定来决定系统的接线尺寸、类型和温度。

尚德组件在供货时配有用于系统电气连接的连接器。推荐的连接器有通灵CABLE01S连接器、安费诺H4连接器、和多触点MC4。尚德强烈建议使用尚德产品数据表中规定的型号的连接器的正品。

为了确保可靠的电气连接并防止可能进入潮气，当两个连接器相互对接时，必须锁住直到听见咔哒声。

长期暴露于潮湿环境中可能导致连接器连接性变差，导致漏电和较差的传导性，这将会使质保无效。尚德建议对连接器/电缆/接线进行适当的管理以防止湿气进入。根据湿气严重程度，尚德建议定期检查安装系统，保证组件的良好性能。

光伏系统产生的直流电可以被转化成交流电，并用于公共电网中。由于各地区机构关于将可再生的能源系统接入电网的政策各不相同，请始终向有资质的系统设计师或集成商咨询相关建议。通常需要安装许可证和当地机构进行检查和批准。

对于较大规模的安装，尚德建议采用符合当地要求和规定的防雷法。

当安装完成并连接到电网后，请准备一份专业的文件交给业主，包括所需的安装协议。同时为业主提供一份清晰的系统文档，至少包括以下资料：用户指南，系统配置，数据表，性能预期，电气系统数据(如符合IEC 62446 / IEC 60364-6最低要求的安装测试报告的副本。)

当接入单个逆变器中的陈列较多时，需要考虑随陈列增加引起的绝缘电阻的降低。

接地

对于接地和连接要求，请参考地区性和国家性安全和电气标准。如果要求接地，请为接地接线使用建议的连接器类型。

本册中的接地指的是组件支架接地。如果要求接地，确保组件支架（暴露的、可接触的的金属部分）始终是接地的。

尚德建议始终参考当地和国家有关光伏组件接地的规范和要求。如果当地机构允许，尚德强烈建议使用负极接地。

必须将支架接地硬件和接线安装到支架上所标注的合适的接地标志位置以确保合适的电气连接。

尚德推荐使用下述一种接地零件：

1) 如下图所示，使用M5螺栓、垫圈在边框预留接地孔处将接地线缆与边框连接固定并形成导通，螺母拧紧力矩为3 ~ 7 N·m。螺母、垫圈均使用不锈钢材质，接地线推荐使用4 ~ 14 mm² (AWG6-12)外露铜线。

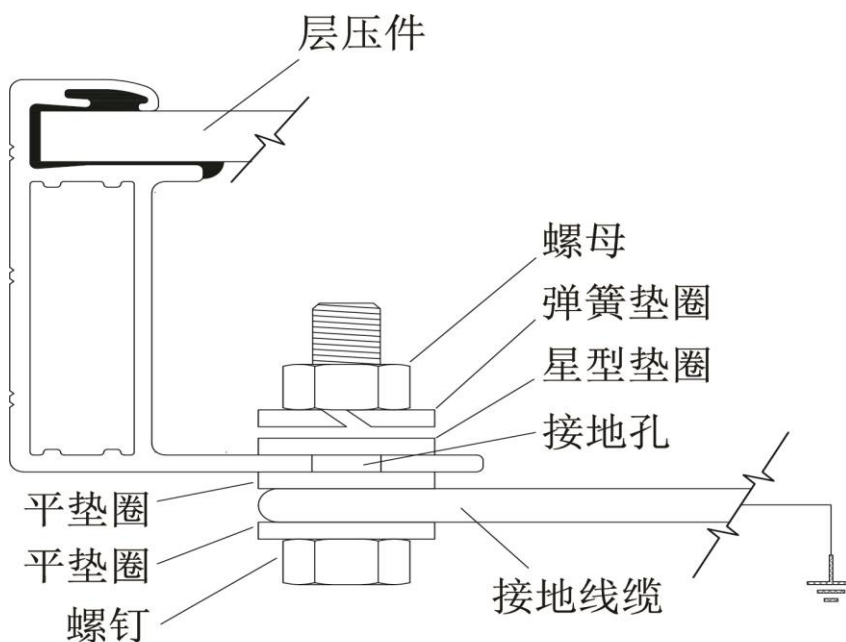

2) 使用WEEB-DPF将太阳能组件安装至组件安装支架上（接地零件接受UL467测试）。

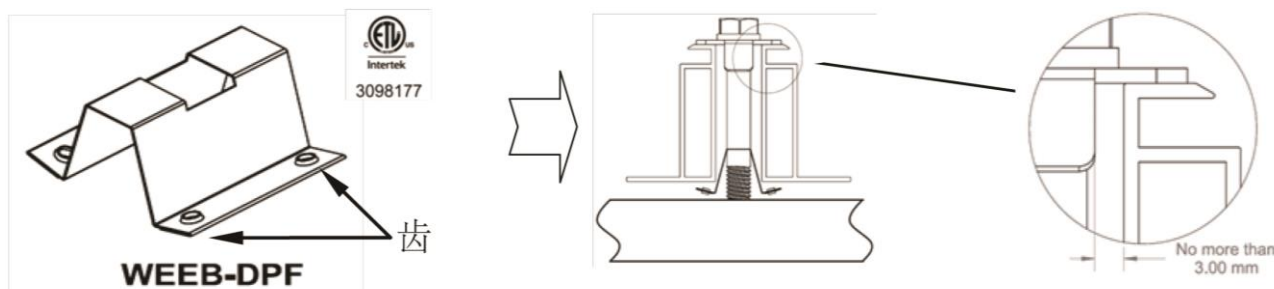

注意：WEEB齿应完全放置在组件支架的边缘下方。

当太阳能组件的位置最终确定后，通常使用20.5牛-米/15英尺-磅的扭矩紧固件放置螺纹卡住。

欲获取更多信息，请联系供应商：BURNDY, <http://www.we-llc.com>。

3) 使用Schletter夹具将太阳能组件安装至组件安装支架（接地零件通过UL467测试）。

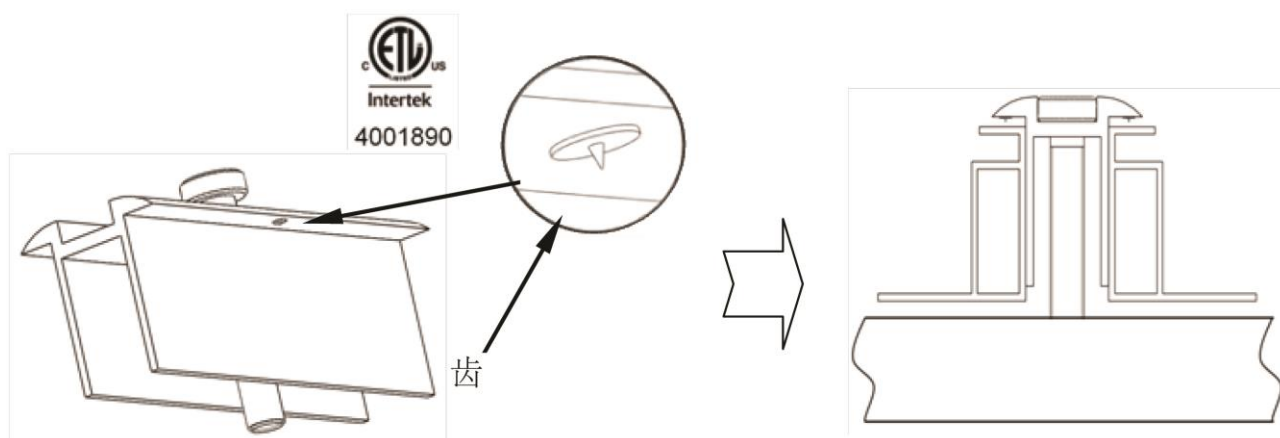

建议夹紧扭矩是20.5牛-米/15英尺-磅。

欲获取更多信息，请联系供应商：Schletter, <http://www.solar.schletter.eu>。

维护

为确保组件的最佳性能，尚德建议采取下列维护措施：

至少一年清洁一次组件或根据污染情况，经常进行清洁。清除表面所有有机物。有污渍或污染物的组件可能会降低系统的发电量。清洁组件表面时请使用清水和柔软的非磨蚀性海绵或布料。也可以使用温和的、非磨蚀性的清洁剂去除顽固污渍。

不受控制的污染以及未及时清洁组件都将会使质保无效。

每隔6个月检查电气、接地和机械连接部位，确保它们干净、安全、没有损坏以及无生锈。否则将会使质保无效。

在出现接地故障时，在由授权的太阳能逆变器服务人员校正并在逆变器完全运行前，切勿使用水清洗或喷洒组件，这可能导致点击事故或严重的安全问题。

若有任何问题，请向专业太阳能服务供应商咨询并寻求建议。

注意：请遵守太阳能制造商对系统中所使用的所有组件的维护说明，例如支架、充电调节器、逆变器、电池等。

无锡尚德太阳能电力有限公司

地址：江苏省无锡市新吴区新华路9号

客户服务热线：+86 400 8888 009 传真：+96 510 8534 3321

邮箱：services@suntech-power.com

或请联系我们的当地代表。访问 www.suntech-power.com 获得详细信息。